

Bringing Better Ideas to the Surface

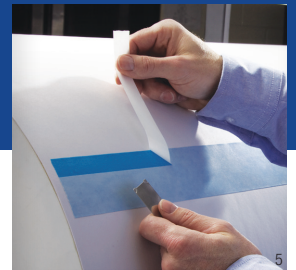

Design & Production Guide
January, 2015

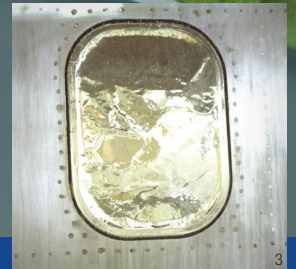

Bringing Better Ideas to the Surface through Science & Innovation

In the 3M Industrial Adhesives and Tapes Division, we apply the science of adhesion to deliver innovative solutions that improve the design and manufacturing processes of companies around the world. In the end, our technologies help customers like you deliver competitive products to the market faster and more efficiently.

Whether you're looking to protect, mask, enhance or otherwise modify surfaces to improve the appearance, function or productivity of your products or processes, this guide will show you what you need to get the job done right.

Solutions through Service...

3M sales representatives are located across the globe. For technical service, a highly trained team can help you evaluate tapes for specific applications. In addition, our national authorized distributor network provides sales assistance and local product availability. Authorized converters can also help you adapt 3M tapes to meet your special requirements.

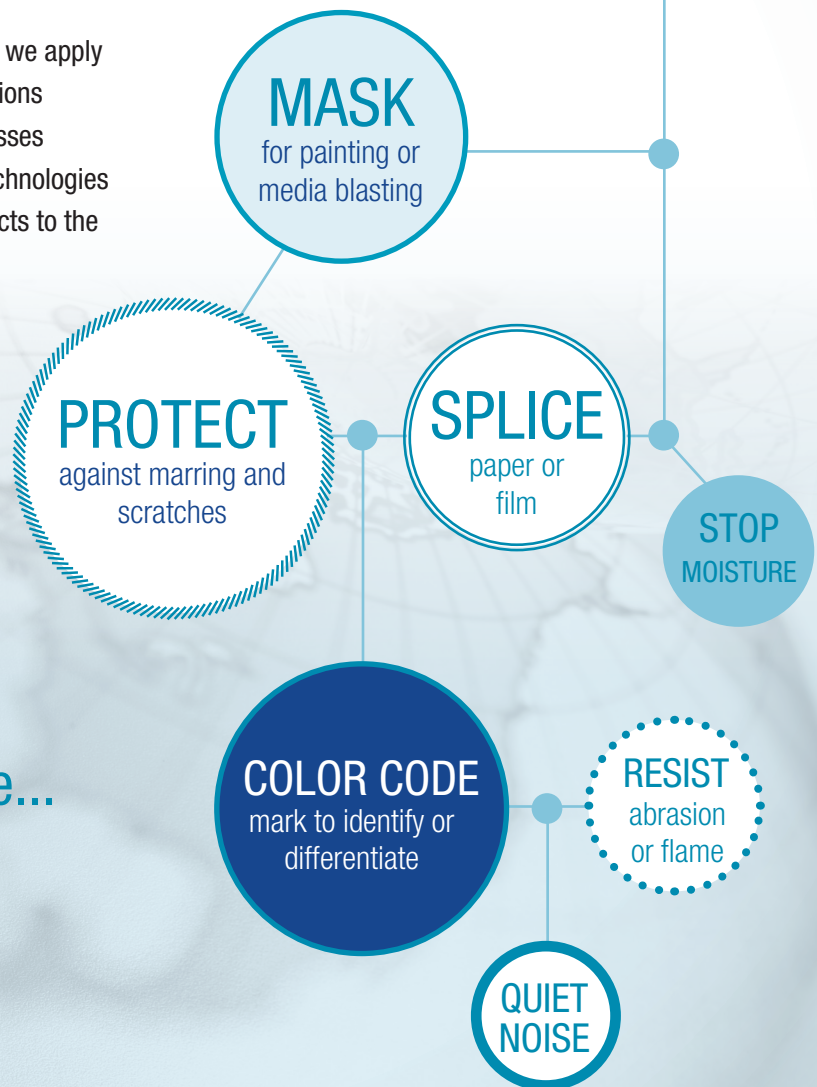

3M Masking and Surface Protection Products

Table of Contents

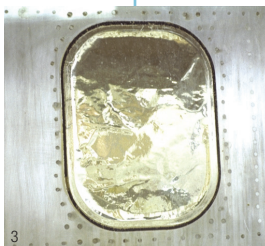

Selecting the Right Product for the Job.....	2-3
3M™ Specialty Tapes Backing and Adhesive Selection Guide	4

Masking, Duct and Flatback Tapes

3M™ Industrial Masking Tapes	6
Scotch® Fine Line Masking Tapes	7
3M™ Masking Tapes — Crepe Paper	8-9
3M™ Duct Tapes and Cloth Tapes.....	10-11
Scotch® Flatback Tapes.....	12
3M™ Masking Films	12

Surface Protection

3M™ Clean-View Pads	14
3M™ Scotchgard™ Multi-Layer Protective Film.....	15
3M™ Protective Tapes	16-19
3M™ Preservation Tapes.....	19
3M™ Sandblast Stencil Products and Impact Stripping Tapes.....	20-21

Specialty Tapes

3M™ Specialty Tapes.....	23
3M™ Application Specific Tapes	24-25
3M™ Glass Cloth Tapes	26
3M™ Metal Foil Tapes.....	27-30
3M™ Sound Damping Foils	31
3M™ Polyester Tapes	32-33
3M™ PTFE and UHMW-PE Tapes.....	34-35
3M™ Vinyl and Polyethylene Tapes	36-37
3M™ Gripping Materials	38

Splicing and Repulpable Tapes

3M™ Splicing and Repulpable Tapes Overview	40
3M™ Repulpable Splicing Tapes.....	41
3M™ Splicing Tapes	42
3M™ Non-Repulpable Splicing Tapes.....	42
3M™ Splicing Tapes Selection Guide	43

Equipment

3M™ Lane Marking Applicators	45
3M™ Tape Dispensers	45
3M™ Dispensers for Large Area Masking.....	46

Technical Appendix for Protective Tapes.....	47
Glossary	48-53
Numerical Index.....	54-55
Product Name Index.....	56-57

Selecting the Right Product for the Job

To help you make sure you find the optimum 3M tape or other adhesive-backed product for your particular application, you'll want to consider several factors:

- Backing material
- Adhesive type
- Application time and temperature
- Surface characteristics (e.g., roughness, surface energy, contours, etc.)
- End use conditions (e.g., temperature, UV exposure, abrasion, etc.)

The following selection guides integrate those factors to help you narrow your selection to fewer products for a more in-depth evaluation.

3M Backing Materials

In many applications, 3M backings add a second surface that affects how the underlying surface relates to the environment.

To optimize that relationship, 3M backings offer a wide choice of performance and handling characteristics.

PAPER BACKING	Crepe	Conformable, easy tear
	Flatback	Strong, smooth, good for straight line masking
	Kraft	Strong, some versions are repulpable
	Tissue	Thin, porous to allow adhesive penetration of sheet
PLASTIC BACKING	Polyester	Strong even when thin, chemical resistant, high temperature resistance
	Polypropylene	Resistant to most solvents, conformable, tear resistant
	Polyethylene	Conformable, easy to stretch, chemical/acid/moisture resistant, economical
	Polyethylene/Polypropylene Co-polymer	Conformable, chemical/acid/moisture resistant
	UHMW-PE	High abrasion resistance, low coefficient of friction, anti-stick surface easy to clean
	Polyvinyl Chloride (Vinyl)	Conformable, abrasion resistant, resistant to most chemicals
	Polyimide	High temperature resistance, excellent dimensional stability, good chemical resistance
	Polyamide (Nylon)	High temperature resistance, high strength and toughness, good chemical resistance but can absorb moisture
	Polytetrafluoroethylene (PTFE)	Low coefficient of friction, excellent high temperature and chemical resistance, anti-stick/release properties
	Polyvinyl Alcohol (PVA)	Water-soluble, organic solvent resistant, high temperature resistance
	Polyurethane	Abrasion/scratch resistant, impact/puncture resistant, UV and corrosion resistant
Polyvinyl Fluoride	Excellent weather resistance, excellent long-term UV resistance, thin yet stiff feel	
CLOTH BACKING	Cotton	Strong, easy tear by hand, soft and drapable
	Glass Cloth	Strong, high temperature resistance, flame-resistant
	Vinyl Coated	Strong yet hand tearable, abrasion resistant, water-resistant, conformable
NON-WOVEN BACKING	Fiber	Air permeable, strong enough to hold expanding foams
METAL BACKING	Aluminum	Heat and light reflective, moisture and chemical resistant, flame-resistant, outdoor weather resistant, conformable
	Copper	EMI/RFI shielding
	Lead	Electrically conductive, acid resistant, high conformability, x-ray opacity
	Stainless Steel	Corrosion resistant
RUBBER BACKING	Neoprene	Abrasion resistant, die-cuttable
COMBINATION (LAMINATES) BACKING	Paper/Polyethylene	Weather and chemical resistant, hand tearable, stretch resistant
	Metalized/Polyester	Reflective, decorative
	Glass Cloth/PTFE	High temperature resistance, high strength
	Glass Cloth/Aluminum	Very high temperature resistance, high strength
	Non-Woven/Aluminum	High heat and cold resistance
	Polyethylene Over Cloth	Strong yet hand tearable, abrasion resistant, water resistant and conformable.

3M Pressure Sensitive Adhesives

Most of the products in this guide feature a 3M pressure sensitive adhesive that bonds the backing to another surface on contact. Each adhesive has different characteristics that affect production and end use performance.

RUBBER ADHESIVE	STANDARD ACRYLIC ADHESIVE	MODIFIED ACRYLIC ADHESIVE	SILICONE ADHESIVE
High initial bond	Moderate initial bond	Bonds to wider variety than standard acrylic	Fair initial bond
Softer	Firmer	Softer	Very firm
Widest variety of surfaces including low surface energy materials*	High surface energy*	Many surfaces	Fewer surfaces
Up to 350°F (177°C)	Up to 450°F (232°C)	Up to 300°F (149°C)	Up to 600°F (316°C), excellent low temperature performance
Fair chemical resistance	Excellent chemical resistance	Good chemical resistance	Excellent chemical resistance
Fair UV resistance	Excellent UV resistance	Moderate UV resistance	Excellent UV resistance
Poor aging	Excellent aging	Durable	Excellent aging
Removable	Permanent	Various	Removable
Good solvent resistance	Excellent solvent resistance	Good solvent resistance	Excellent solvent resistance

*Surface energy ranges from high to low. To illustrate the concept of surface energy, think of water on the unwaxed hood of a car. The unwaxed hood has high surface energy and water on the hood flows into puddles. In comparison, a waxed hood has low surface energy and the water beads up rather than flows out. Similar to water, adhesive on a high surface energy surface flows and "wets out" the surface. "Wetting out" is required to form a strong bond.

As a rule of thumb, the higher the surface energy, the greater the strength of adhesion. Specially formulated adhesives are available for low surface energy surfaces. Regardless of surface energy, the substrate must be unified, dry, and clean to maximize adhesive contact.

The following illustrations and surface rankings give you an idea of relative surface energy.

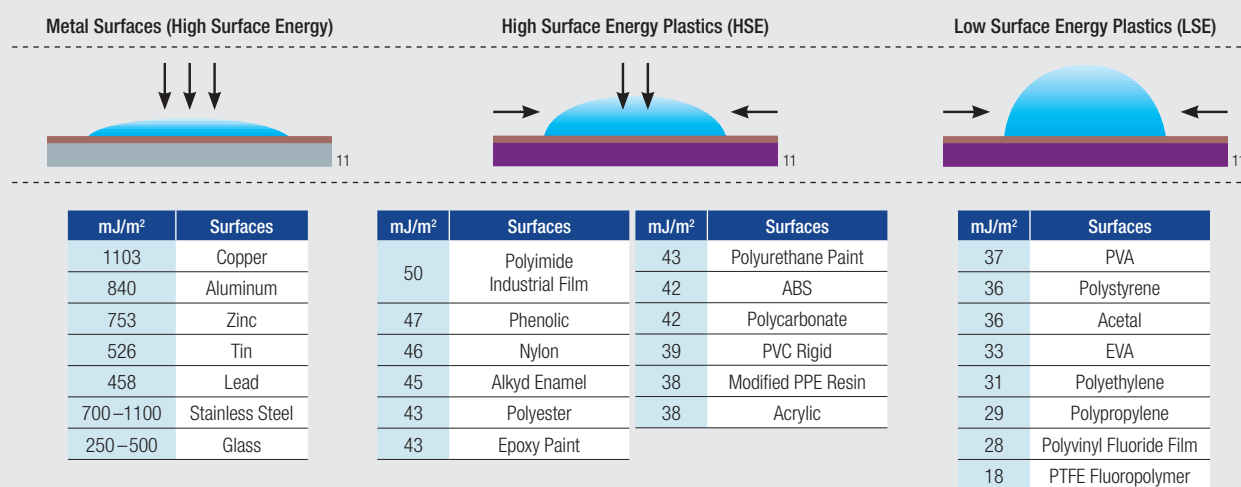

Note: These values are provided as a guide. Formulation modifications can substantially alter surface energies.

Adhesive Surface Contact

Applying firm pressure to the bond increases adhesive flow and contact for more secure bonding. Time and temperature will typically further increase contact and adhesion values.

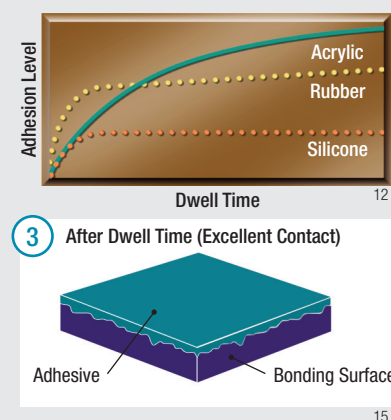
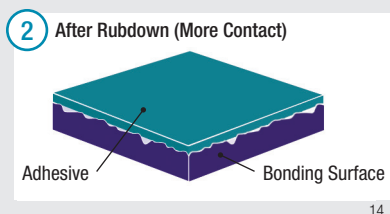
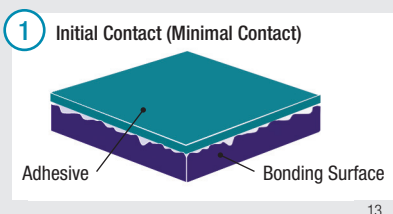

3M™ Specialty Tapes Backing and Adhesive Selection Guide

To help select the **TAPE BACKING** for your application, consult the following charts. Each backing is rated in eight critical categories.

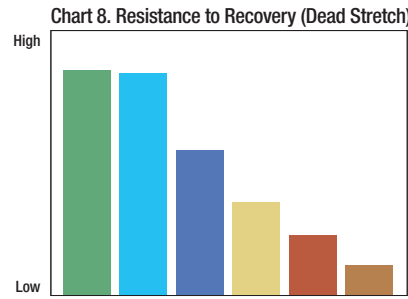
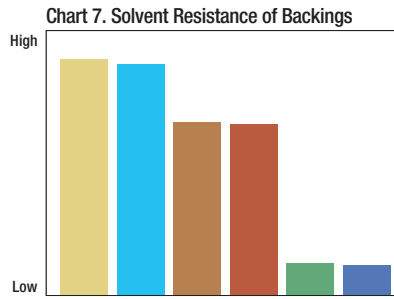
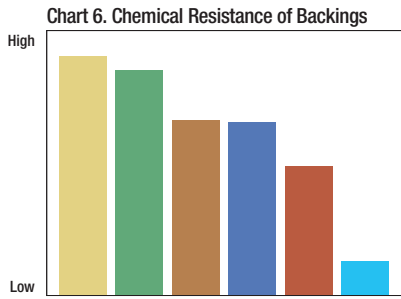
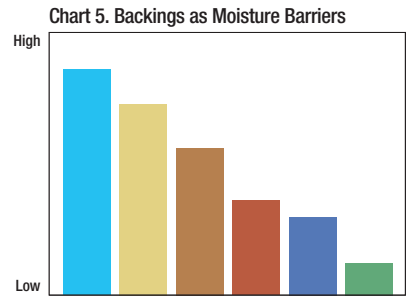
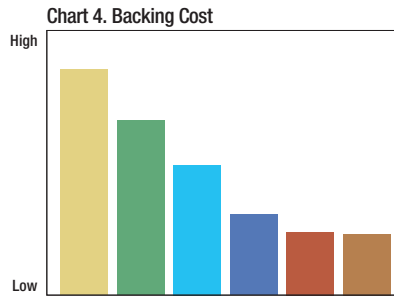
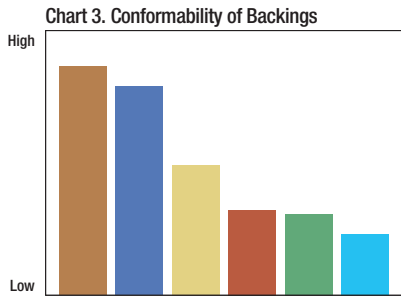
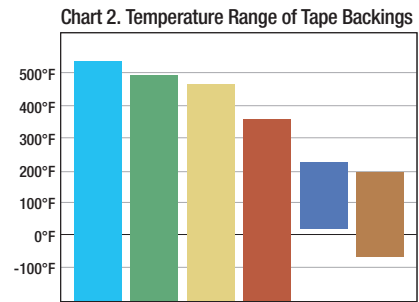
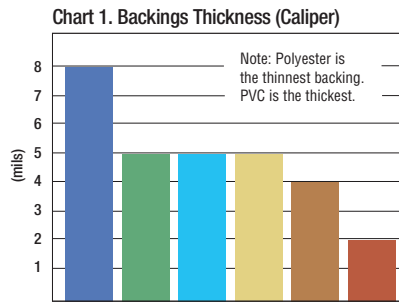
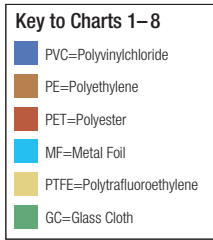

To help select the **ADHESIVE** for your application, consult the charts below. Each adhesive is rated in five critical categories.

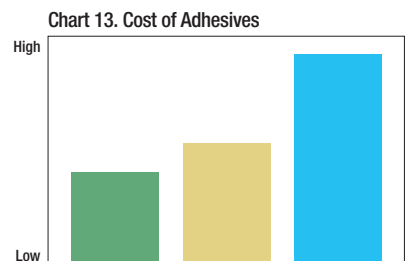
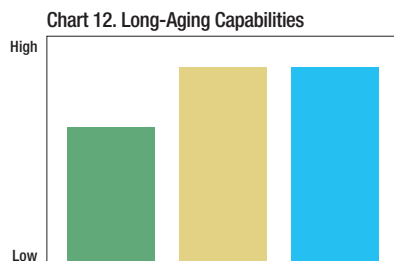
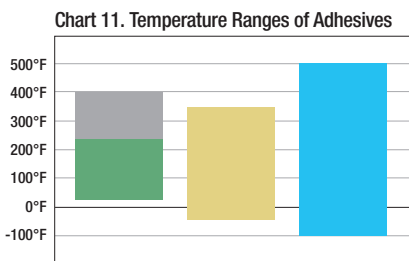
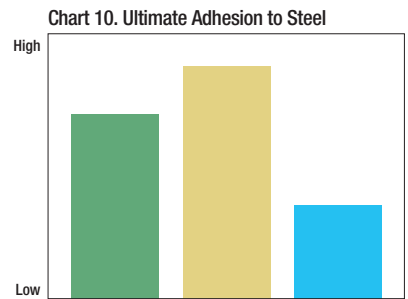
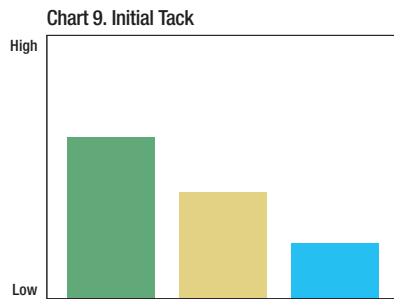
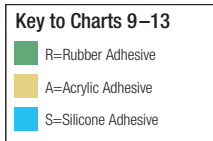

Note: The technical information and data on these pages should be considered representative or typical only and should not be used for specification purposes.



Masking, Duct and Flatback Tapes

Practical Tape Solutions

Tapes that hold firm, yet remove easily

To get the job done right the first time, you need to use the right tools. That's why we offer a full lineup of industrial tapes with unmatched dependability. From tapes that withstand extreme temperatures to tapes that remove cleanly in UV conditions, you can trust 3M to help you get the job done right.

3M™ Industrial Masking Tapes

Now It's Easy to Choose the Best Tape to Get the Job Done Right

To win in today's highly competitive marketplace, you need the right tools. And that includes your masking tapes. So 3M has created a simple, 5-tape system to help you choose the right tape for your job.

Five tapes, built on increasing levels of performance and a common goal of helping you finish jobs worth finishing.

It's industrial masking made simple.



3M™ Masking Tapes 101+, 201+, 301+, 401+ and 501+.



Consider 301+ for general purpose, low to medium temperature applications up to 225°F (107°C).



Consider 401+ for critical masking applications with temperatures up to 250°F (121°C).



Consider 501+ for bake temperatures up to 300°F (149°C) or for multiple bake cycles.

Product Number	Color	Adhesive Type	Backing Material	Total Thickness mils (mm)	Adhesion to Steel oz/in (N/100 mm)	Tensile Strength lb/in (N/100 mm)	Elongation at Break %	Maximum Operating Temperature °F (°C)	Time at Maximum Temperature (mins.)	Can be Certified to Specification	Comments
Based on ASTM Test Method:				D-3652	D-3330	D-3759	D-3759				
101+	Tan	Rubber	Crepe Paper	5.1 (0.13)	34 (37)	22 (385)	9	150 (66)	30	—	Indoor use. Light-duty applications.
201+	Tan	Solvent-Free Rubber	Crepe Paper	4.4 (0.11)	25 (27)	19 (333)	8	200 (93)	30	—	General indoor use. Light-to-medium duty. Clean removal.
301+	Yellow	Solvent-Free Rubber	Crepe Paper	6.3 (0.16)	30 (33)	22 (385)	12	225 (107)	30	—	Good conformability to irregular surfaces. Good paint lines.
401+	Green	Solvent-Free Rubber	Crepe Paper	6.7 (0.17)	36 (39)	25 (438)	10	250 (121)	30	—	Highly conformable to many surfaces. Superior adhesion to metal, rubber, glass and plastic. Great paint lines.
501+	Tan	High Temperature Rubber	Crepe Paper treated with a heat resistant saturant	7.3 (0.19)	36 (39)	26 (455)	10	300 (149)	30	ASTM D 6123	Exceptionally conformable to irregular surfaces. Superior adhesion to metal, rubber, glass and plastic. Removes cleanly in one piece with no residue. Great paint lines.

Note: The technical information and data on these pages should be considered representative or typical only and should not be used for specification purposes.

Scotch® Fine Line Masking Tapes

Line Sharpness and Removal the Way You Want

With a core capability of coating technology, 3M combines paper or film backings with different adhesives for demanding applications.

- Sharpest possible paint lines
- Conformability to stretch and adhere around sharp curves
- Film or vinyl backings flex easily for creating curved paint edges
- Resist edge lifting



With blue vinyl backing and rubber adhesive, Scotch® Fine Line Masking Tape 4737T offers best-in-class conformability and line sharpness for curves in high value processes.



A combination of Scotch® Fine Line Masking Tape and 3M™ Crepe Masking Tape helps to create sharp, high-impact paint lines on an in-mold application in the marine industry.

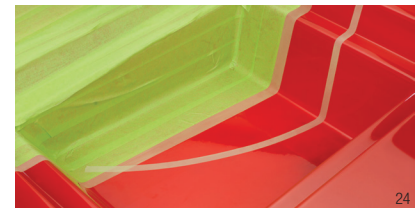

Also consider Scotch® Fine Line Tape 265 for difficult to stick to surfaces, such as semi-perm mold release surfaces.

Product Number	Color	Adhesive Type	Backing Material	Total Thickness mils (mm)	Adhesion to Steel oz/in (N/100 mm)	Tensile Strength lb/in (N/100 mm)	Elongation at Break %	Maximum Operating Temperature °F (°C)	Time at Maximum Temperature (minutes)	Comments
Based on ASTM Test Method:				D-3652	D-3330	D-3759	D-3759			
215	Blue	Rubber	Polyethylene/ Polypropylene Co-polymer	4.8 (0.12)	43 (47)	15 (263)	1150	250 (121)	30	Medium temperature. Excellent conformability.
218	Green	Rubber	Polypropylene	5.0 (0.13)	37 (40)	13 (228)	720	250 (121)	30	Good for long, straight lines.
218L	Green	Rubber	Polypropylene	5.0 (0.13)	37 (40)	13 (228)	720	250 (121)	30	Lined version of 218 tape.
265	Green	Rubber/ Silicone	Polypropylene	5.1 (0.13)	21 (23)	21 (368)	881	200 (93)	30	In-mold composite masking where sharp, clean, gel-coat color separation lines are desired.
2460	Gold	Acrylic	Flatback Paper	3.3 (0.08)	8 (8.7)	17 (297)	5	300 (149)	30	For paint bake operations at temperatures up to 300°F (149°C). 14 days outdoor.
2480S	Green	Acrylic	Flatback Paper	4.0 (0.10)	13 (14.2)	18 (315)	6	200 (93)	30	A thin, strong, smooth flat back paper that gives sharp paint lines with low paint ridge. 60 days outdoor.
4735	Orange	Rubber	Vinyl	5.4 (0.14)	9.5 (10.4)	14 (245)	130	300 (149)	30	Highly conformable, high temperature vinyl fine line tape for fascia panels, two-tone and other multiple color applications where critical paint break lines are required.
4737T	Translucent Blue	Rubber	Vinyl	5.4 (0.14)	10.5 (11.5)	16 (280)	115	300 (149)	30	Conformable, high temperature vinyl fine line tape for fascia panels, two-tone and other multiple color applications where critical paint break lines are required.
4737S	Solid Blue	Rubber	Vinyl	5.4 (0.14)	10.5 (11.5)	16 (280)	115	300 (149)	30	Highly visible backing version of 4737T.
4737TL	Blue	Rubber	Vinyl	5.4 (0.14)	10.5 (11.5)	16 (280)	115	325 (163)	30	Lined version of 4737T.

Note: The technical information and data on these pages should be considered representative or typical only and should not be used for specification purposes.

3M™ Masking Tapes — Crepe Paper

Holding Power and Removal the Way You Want

In this simplified line, you will find a range of such characteristics as adhesive holding power, line sharpness, and clean removal to meet different application requirements for virtually every industrial and consumer application. 3M products also feature:

- Instant adhesion at a touch
- Easy tear without stretching or pulling
- Controlled unwind...not too easy or too hard
- Conformability to stretch and adhere around curves



With the wide variety of 3M™ Masking Tapes, you can select from a variety of backings, adhesion strengths, clean removal properties, and temperature range performance.



Use 3M™ Value Masking Tape 101+ for light-duty attaching.



Use 3M™ General Masking Tape 201+ to quickly bundle parts.



3M™ Performance Yellow Masking Tape 301+ is ideal for labeling and identifying applications.

Learn more about Sustainable Solutions from 3M online at www.3M.com/sustainability

3M™ Masking Tapes — Crepe Paper

Product Number	Color	Adhesive Type	Backing Material	Total Thickness mils (mm)	Adhesion to Steel oz/in (N/100 mm)	Tensile Strength lb/in (N/100 mm)	Elongation at Break %	Maximum Operating Temperature °F (°C)	Time at Maximum Temperature (mins.)	Can be Certified to Specification	Cross Reference	Comments
ASTM Test Method:				D-3652	D-3330	D-3759	D-3759					
Industrial Masking Tapes												
101+	Tan	Rubber	Crepe Paper	5.1 (0.13)	34 (37)	22 (385)	9	150 (66)	30	—	—	Indoor use. Light-duty applications.
201+	Tan	Solvent-Free Rubber	Crepe Paper	4.4 (0.11)	25 (27)	19 (333)	8	200 (93)	30	—	—	General indoor use. Light-to-medium duty. Clean removal.
301+	Yellow	Solvent-Free Rubber	Crepe Paper	6.3 (0.16)	30 (33)	22 (385)	12	225 (107)	30	—	—	Good conformability to irregular surfaces. Good paint lines.
401+	Green	Solvent-Free Rubber	Crepe Paper	6.7 (0.17)	36 (39)	25 (438)	10	250 (121)	30	—	—	Highly conformable to many surfaces. Superior adhesion to metal, rubber, glass and plastic. Great paint lines.
501+	Tan	High Temperature Rubber	Crepe Paper Treated with a Heat Resistant Saturant	7.3 (0.19)	36 (39)	26 (455)	10	300 (149)	30	ASTM D 6123	—	Exceptionally conformable to irregular surfaces. Superior adhesion to metal, rubber, glass and plastic. Removes cleanly in one piece with no residue. Great paint lines.
General Purpose Masking Tapes												
200	Tan	Rubber	Crepe Paper	4.4 (0.11)	25 (27)	19 (333)	8	200 (93)	30	—	201+	Good instant adhesion.
202	Tan	Rubber	Crepe Paper	6.3 (0.16)	37 (41)	27 (472)	8	250 (121)	30	ASTM D 6123; D 6123M-97	401+	Good holding power.
203	Beige	Rubber	Crepe Paper	4.7 (0.12)	28 (31)	22 (385)	8	200 (93)	30	—	201+	General purpose masking tape for holding, bundling, sealing and more.
213	Tan	Rubber	Crepe Paper	6.0 (0.15)	34 (37)	27 (480)	10	350 (177)	30	ASTM D 6123; D 6123M-97	—	Good on anodized aluminum.
214	Tan	Rubber	Crepe Paper	5.8 (0.15)	29 (32)	27 (480)	10	350 (177)	60	ASTM D 6123; D 6123M-97	—	Stain resistant.
225	Silver	Rubber	Crepe Paper	5.8 (0.15)	33 (36)	21 (368)	9	200 (93)	30	—	—	Outdoor use.
226	Black	Rubber	Polyethylene/ Crepe Paper	10.6 (0.27)	38 (42)	34 (595)	11	225 (107)	30	—	—	Outdoor use.
231/231A	Tan	Rubber	Crepe Paper	7.6 (0.19)	38 (41)	28 (490)	10	300 (149)	30	ASTM D 6123; D 6123M-97	501+	Best all-purpose paint masking tape.
232	Tan	Rubber	Crepe Paper	6.3 (0.16)	37 (41)	27 (472)	8	250 (121)	30	—	401+	Good paint lines.
234	Tan	Rubber	Crepe Paper	5.9 (0.15)	34 (37)	27 (472)	8	250 (121)	30	ASTM D 6123; D 6123M-97	401+	Excellent controlled unwind.
2214	Tan	Rubber	Crepe Paper	5.4 (0.14)	22 (24)	23 (403)	10	200 (93)	30	—	101+	Good for holding and bundling.
2307	Tan	Rubber	Crepe Paper	5.2 (0.13)	28 (31)	23 (403)	8	200 (93)	30	—	301+	Solvent-free construction, non-critical paint masking.
2308	Tan	Rubber	Crepe Paper	5.3 (0.13)	35 (38)	22 (385)	10	250 (121)	30	—	301+	Good transfer resistance.
2364	Tan	Rubber	Crepe Paper	6.5 (0.17)	31 (34)	24 (427)	10	300 (149)	30	ASTM D 6123; D 6123M-97	501+	High temperature, crepe paper masking tape for general masking application. Good holding power.
2380	Tan	Rubber	Crepe Paper	7.2 (0.18)	39 (43)	28 (498)	10	325 (163)	30	ASTM D 6123; D 6123M-97	501+	High temperature. Best holding to widest variety of surfaces.
2393	Tan	Rubber	Crepe Paper	7.6 (0.19)	32 (36)	28 (490)	11	325 (163)	30	ASTM D 6123; D 6123M-97	—	Smooth, heavy duty, high temperature masking tape.
2510	Black	Rubber	Crepe Paper	5.6 (0.14)	35 (37)	20 (350)	9	200 (93)	60	ASTM D 6123; D 6123M-97	—	General purpose masking tape for holding, bundling, sealing and general paint masking where a dark colored tape is required.
2693	Tan	Synthetic Rubber	Crepe Paper	7.9 (0.20)	40 (44)	29 (515)	10	325 (163)	30	ASTM D 6123; D 6123M-97	501+	Very aggressive holding; excellent for multi-bake paint cycles.

Note: The technical information and data on these pages should be considered representative or typical only and should not be used for specification purposes.

3M™ Duct Tapes and Cloth Tapes

Dependability and Versatility for Bundling, Sealing, Reinforcing and More

This family of rugged cloth and duct tapes adheres to most surfaces for applications ranging from bundling to moisture proofing, sealing to splicing, reinforcing to hanging poly drapes. Features include:

- Hand tearable
- High tensile strength
- Conformability

Latest innovation in the line — clean removal plus long life indoors and out

The line includes 3M™ Performance Plus Duct Tape 8979 and nuclear grade 8979N. The best performing 3M™ Duct Tapes under the sun:

- Remove cleanly for up to six months from most opaque surfaces even after exposure to sun and outdoor weathering
- Stay on for up to one year without deterioration
- Save time and hassle of removing sticky or dried-on residue
- Strong waterproof backing resists wear, abrasion, moisture, and weathering

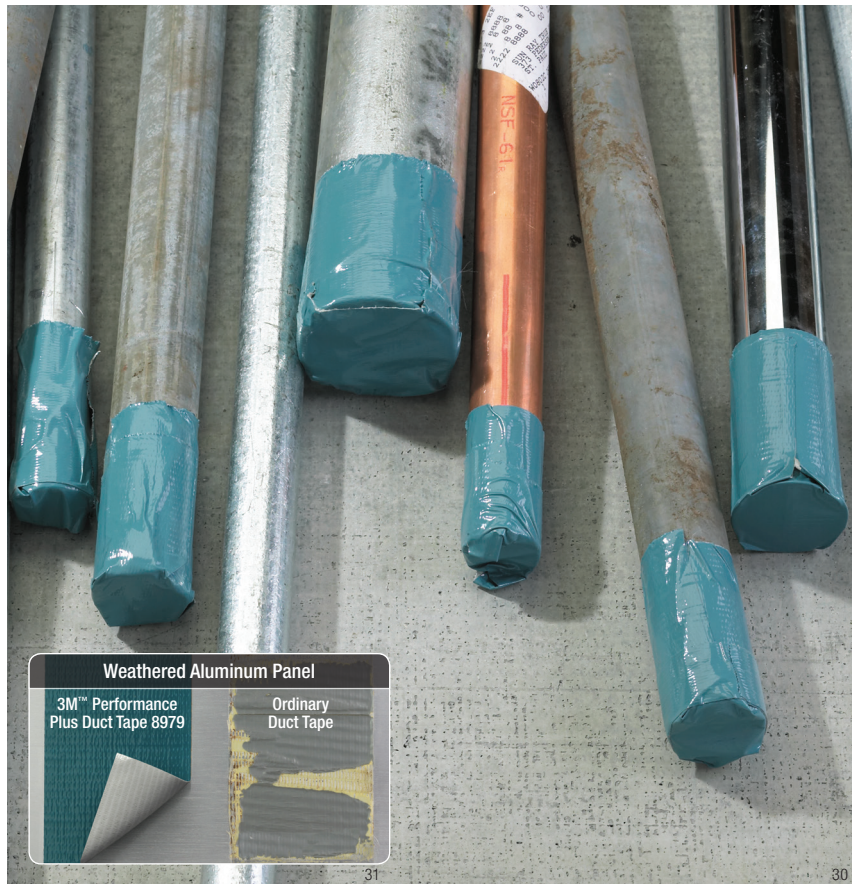

3M™ Duct Tapes are available in a variety of colors for color coding. A range of widths provides choices in coverage from 24mm to 22 inches.

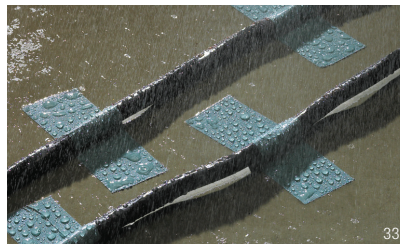

Waterproof backing of 3M™ Performance Plus Duct Tape 8979 resists moisture and rain for up to a year.



Write on the surfaces of many 3M™ Duct Tapes with pen or marker to leave a reminder or mark and identify works-in-progress, components, items bundled and more.



For a tight seal in many containment situations, 3M™ Performance Plus Duct Tape 8979 attaches heavy poly draping, closes cuffs, and then removes cleanly when the job is finished.



Strong backing of 3M™ Outdoor Masking and Stucco Tape 5959 pulls through stucco, EIFS and other heavy coatings in one piece.



For bundling a wide variety of items, 3M™ Duct Tapes with natural rubber adhesive and high tensile strength backings adhere on contact and hold securely.

3M™ Duct Tapes and Cloth Tapes

Product Number	Color	Adhesive Type	Backing Material	Thickness mils (mm)	Adhesion to Steel oz/in (N/100 mm)	Tensile Strength lb/in (N/100 mm)	Elongation at Break %	Maximum Operating Temperature °F (°C)	Meets Specifications	Comments
Based on ASTM Test Method:				D-3652	D-3330	D-3759	D-3759			
Clean Removal Duct Tapes										
8979	Blue, Black, Olive	Rubber	Polyethylene Over Cloth Scrim	12.1 (0.31)	48 (53)	36 (630)	19	200 (93)	UL 723/ASTM E84	Up to six months clean removal from most opaque surfaces indoors and outdoors.
8979N	Red, Blue	Rubber	Polyethylene Over Cloth Scrim	12.1 (0.31)	48 (53)	36 (630)	19	200 (93)	UL 723/ASTM E84/MIL-STD-2041D	Same features as 8979, plus low halogen and sulfur.
5959	Red	Rubber	Polyethylene Over Cloth Scrim	12.0 (0.30)	53 (58)	35 (613)	21	200 (93)	UL 723/ASTM E84	High tensile strength backing protects against stucco, EIFS and other heavy coatings. 3 months outdoors.
5903	Red	Synthetic Rubber	Polyethylene	7.5 (0.19)	79 (87)	21 (368)	72	173 (78)	—	UV and weather resistant for outdoor masking, holding, patching, bundling, marking and more. 30 day removal.
Professional Grade Duct Tapes										
2979	Silver	Synthetic Rubber	Polyethylene Over Cloth Scrim	7.4 (0.29)	79 (86)	24 (430)	21	200 (93)	—	Use for a variety of duct tape applications.
3900	Black, Blue, Olive, Red, Silver, White, Yellow	Rubber	Polyethylene Over Cloth Scrim	7.6 (0.19)	53 (58)	28 (490)	19	200 (93)	—	General purpose duct tape, temporary repairs, color-coding.
3939	Silver	Rubber	Polyethylene Over Cloth Scrim	8.6 (0.22)	55 (60)	25 (438)	17	200 (93)	UL 723/ASTM E84	Use for demanding duct tape applications.
3979	Silver	Synthetic Rubber	Polyethylene Over Cloth Scrim	7.9 (0.31)	68 (74)	32 (560)	26	200 (93)	—	Use for a variety of duct tape applications.
6969	Silver	Rubber	Polyethylene Over Cloth Scrim	10.0 (0.25)	51 (56)	34 (595)	16	200 (93)	UL 723/ASTM E84	Industrial grade duct tape, thick adhesive layer sticks to rough surfaces.
Utility Duct Tapes										
3903	Black, Blue, Gray, Green, Red, White, Yellow	Rubber	Vinyl	6.5 (0.16)	15.4 (16.8)	12.6 (220)	134	200 (93)	—	General purpose tape for color coding and marking. Embossed vinyl backing.
2929	Silver	Rubber	Polyethylene Over Cloth Scrim	5.5 (0.14)	45 (49)	19 (333)	14	200 (93)	—	Utility grade duct tape for temporary repairs, sealing, holding and marking.
1900	Silver	Synthetic Rubber	Polyethylene Over Cloth Scrim	5.8 (0.15)	62 (68)	19 (333)	15	200 (93)	—	Economical choice for sealing, holding and marking.
Specialized High Strength Tapes										
390	Silver, Olive	Rubber	Polyethylene Over Cloth Scrim	11.7 (0.30)	114 (125)	48 (841)	12	200 (93)	—	Highest tensile for most demanding jobs, olive for military requirements.
393	Silver	Rubber	Polyethylene Over Cloth Scrim	12.0 (0.30)	95 (104)	36 (632)	8	200 (93)	—	High adhesion, easy tear, for moisture proofing and insulation sealing.
6910	Silver	Rubber	Vinyl Coated Cloth	12.0 (0.30)	45 (49)	45 (788)	5	200 (93)	—	Excellent grip/gaffer's tape. Matte finish tape for low light reflectance.

Note: The technical information and data on these pages should be considered representative or typical only and should not be used for specification purposes.

Scotch® Flatback Tapes

With a core capability of coating technology, 3M offers a range of backings and adhesive strengths to hold up to your job.

- High strength backings with strong cross direction tensile properties used for tabbing and splicing
- Highly visible backing to help you identify and remove splices

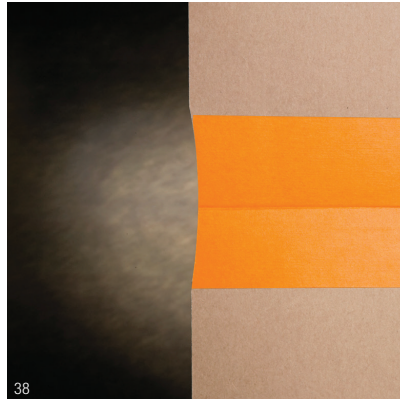

Scotch® Flatback Tape 2525 is great for applications requiring a unique color.

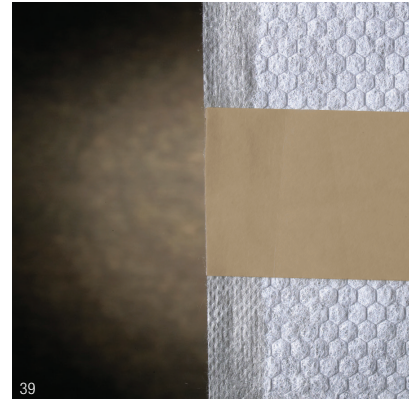

Scotch® Flatback Tape 2517 is great for low or high temperature splicing.

Product Number	Color	Adhesive Type	Backing Material	Total Thickness mils (mm)	Adhesion to Steel oz/in (N/100 mm)	Tensile Strength lb/in (N/100 mm)	Elongation at Break %	Maximum Operating Temperature °F (°C)	Time at Maximum Temperature (mins.)	Can be Certified to Specification	Comments
Based on ASTM Test Method:				D-3652	D-3330	D-3759	D-3759				
250	Tan	Rubber	Flatback Paper	6.0 (0.15)	78 (85)	59 (1033)	4	125 (52)	30	ASTM D 6123; D 6123M-97	Used in paint adhesion testing.
256	White, Red, Green	Rubber	Flatback Paper	6.7 (0.17)	25 (27)	20 (350)	5	200 (93)	60	ASTM D 6123; D 6123M-97	Printable, accepts marking inks.
2515*	Tan	Rubber	Kraft Paper	6.7 (0.17)	55 (60)	36 (630)	3	200 (93)	30	—	General purpose splicing, holding and bundling applications.
2517	Medium Brown	Rubber	Kraft Paper	6.5 (0.15)	78 (85)	35 (543)	2	300 (149)	30	ASTM D 6123; D 6123M-97	Excellent splicing, holding and bundling applications.
2525	Orange	Rubber	Flatback Paper	9.5 (0.24)	69 (75)	49 (858)	2	300 (149)	60	—	Premium splicing, bright color.
2526	White	Rubber	Flatback Paper	9.8 (0.24)	69 (75)	50 (858)	4	300 (149)	60	—	Excellent adhesion and strength for textile applications.

*Tartan brand.

3M™ Masking Films

Product Number	Color	Adhesive Type	Backing Material	Total Thickness mils (mm)	Tensile Strength lb/in (N/100 mm)	Elongation at Break %	Maximum Operating Temperature °F (°C)	Time at Maximum Temperature (mins.)	Comments
Based on ASTM Test Method:				D-3652	D-3759	D-3759			
7260M	Translucent	n/a	Polypropylene	1.8 (0.04)	5 (88)	700	315 (157)	60	Designed for masking cars and light trucks during OEM painting and for industrial paint masking applications such as truck, bus, RV heavy equipment and aircraft. Large area bags and sheets.
7300	Translucent	n/a	Polypropylene	3.4 (0.09)	7.4 (130)	680	310 (155)	60	High performance, high temperature masking film that is soft flexing for good drape and conformability. Single wound slit rolls in a variety of widths.



Surface Protection

Protection Where You Need It

Innovative 3M tapes and films can protect surfaces by resisting abrasion, UV, heat and punctures. Our surface protection products adhere and conform to numerous surfaces for maximum protection, and then remove easily. When your products need protection, you can trust 3M for practical solutions.

3M™ Clean-View Pads

Reliable Protection Against Paint Overspray

This clear multi-sheeted adhesive system protects paint booth windows and light fixtures from overspray. You reduce the labor expense, downtime, and amount of chemicals used for cleanup.

- Clear polyethylene keeps paint out and lets light through to help brighten the work area
- Individually tabbed sheets for easy removal from the pad
- Eliminates re-application of single layer protection films
- Acrylic adhesive system for adhesion to glass surfaces



Reliable protection is easy with 3M™ Clean-View Pads. Simply remove the clear protective liner to expose adhesive. Adhere the top adhesive edge to a dry, clean surface and squeegee over the bond area. When the sheet becomes contaminated, peel away to reveal a fresh, ready-to-use sheet.



For large and small painting operations, 3M™ Clean-View Pads protect windows and light fixtures from overspray.



3M™ Clean-View Pads help reduce the cost, downtime, and chemicals used in conventional cleanup.

Product Number	Quantity	Sizes Inches (mm)	Pad/Adhesive	Color	Total Layer Thickness mils (mm)	Backing Layer Thickness mils (mm)	Adhesive Layer Thickness mils (mm)	Adhesion to Steel oz./in. (N/100 mm)	Comments
5850	20 sheets/pad 6 pads/case	13 x 51 (330 x 1295)	Polyethylene/ Acrylic	Clear	1.83 (0.05)	1.2 (0.03)	0.63 (0.02)	8.0 (9.0)	Ideal for paint booth operation. Protects from paint overspray.
	20 sheets/pad 6 pads/case	18 x 46 (457 x 1168)	Polyethylene/ Acrylic	Clear	1.83 (0.05)	1.2 (0.03)	0.63 (0.02)	8.0 (9.0)	
	20 sheets/pad 6 pads/case	24 x 50 (609 x 1270)	Polyethylene/ Acrylic	Clear	1.83 (0.05)	1.2 (0.03)	0.63 (0.02)	8.0 (9.0)	
	20 sheets/pad 6 pads/case	24 x 36 (609 x 914)	Polyethylene/ Acrylic	Clear	1.83 (0.05)	1.2 (0.03)	0.63 (0.02)	8.0 (9.0)	

Note: The technical information and data on these pages should be considered representative or typical only and should not be used for specification purposes.

3M™ Scotchgard™ Multi-Layer Protective Film

Easy, Cost-Effective Graffiti Removal

Transit authorities can spend millions annually to maintain and repair interior windows and glass. Specialized labor for replacing glass and materials cost add up quickly.

On interior windows you can simply peel away graffiti with 3M™ Scotchgard™ Film.

Choices with **multi-layer protection** save you time and money while maintaining windows that are free from scratches, graffiti and acid-etched marks. When one layer is defaced, simply peel it away to refresh the window quickly and easily.

- Minimal training to install
- Clean removal of each layer with no adhesive residue on the glass
- Optically transparent view
- Clean removal — no adhesive residue left behind
- Protection from acid, scratches, permanent marker, hard water stains
- High clarity for glass-like appearance



Easy-to-apply 3M™ Scotchgard™ Multi-Layer Protective Film adheres to any flat glass that is free of dirt, debris and oils. Four layers are as clear as glass to see through.



45



46

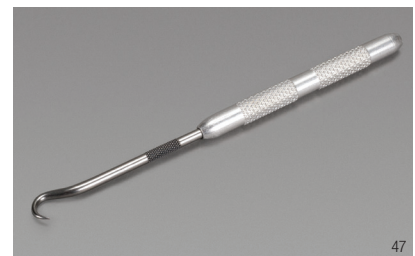

47

With 3M™ Scotchgard™ Multi-Layer Protective Film on the inside of public transportation windows, vandals deface one layer of four protective layers not the glass. The defaced layer is simply and cleanly removed to reveal a new layer of protection. 3M optimized adhesives provide long-term adhesion and clean, easy removal between each layer and the last layer from the glass.

Simply pick and lift the corner, then peel off the defaced sheet.

	3M™ Scotchgard™ Multi-Layer Protective Film 1004	3M™ Scotchgard™ Multi-Layer Protective Film 1004MS Series		
	<ul style="list-style-type: none"> • For clean removal on surfaces such as glass, mirrors, polished stainless steel and other smooth surfaces. 	<ul style="list-style-type: none"> • More aggressive adhesive system for polycarbonates, acrylics, brushed stainless steel and other slightly porous surfaces. 		
Product #	1004	1004MS	1002MS	1001MS
Layers/Sheet	4	4	2	1
Quantity	20 sheets/case	20 sheets/case	20 sheets/case	1 roll/case
Size	60" x 72" or 60" x 60" (Custom cut sizes available based on volume)	60" x 72" or 60" x 60" (Custom cut sizes available based on volume)	60" x 72"	58.5" x 100 ft. roll

Note: The technical information and data on these pages should be considered representative or typical only and should not be used for specification purposes.

3M™ Protective Tapes

Protection Against Scratching, Marring, Chipping, Abrasion and UV

These rugged 1–5 mil tapes adhere and conform to protect product surfaces during production, packaging, shipping and installation. Tack level varies depending on the tape. All remove cleanly once the product is in the hands of the end user.

A variety of backings are available and each offers key characteristics:

Polyethylene Tapes

- Transparent with good abrasion resistance
- Cost-effective

UV Tapes

- Transparent or blue with enhanced outdoor UV resistance

Carpet Tapes

- Transparent with easy unwind

Self Sealing Tapes

- Clear film seals to itself for packaging small parts

Co-Extruded “A” Tapes

- Puncture resistance and break strength surpass many typical LDPE films

Co-Extruded Black/White Tapes

- UV resistance up to 9 months

Polyester Tapes

- Best choice for clarity with excellent heat and puncture resistance

Polypropylene Tapes

- Good resistance to heat, abrasion and UV



During manufacturing and transport, transparent 3M™ Polyethylene Protective Tapes protect many finished automotive interior surfaces from abrasion, nicks, and scratches. Clear acrylic adhesive holds with very low tack for easy removal.



To help ensure a scratch-free surface for the end user, 3M™ Co-Extruded “A” Tape is applied after final finishing to sinks, spas, and countertops prior to packaging. Enhanced abrasion and puncture resistance protects the surface through shipping and installation. Tape then removes cleanly.

3M™ Protective Tapes

Nominal Results

Product	Tape Structure (Backing/Adhesive)	Total Thickness mils (mm)	Adhesion to Steel oz./in. width	Tack Level	Elongation at Break (%)	Application Ideas
Based on ASTM Test Method:		D-3652	D-3330		D-3759	
Co-Extruded "A" Tapes						
25A825	Co-Extruded/Acrylic	2.5 (0.06)	6	Medium	600	Semi-gloss painted metals and plastic surfaces. Automotive moldings.
25A826	Co-Extruded/Acrylic	2.5 (0.06)	7	Medium	600	Embossed, painted metal building panels. Molded fiberglass.
25A829	Co-Extruded/Acrylic	2.5 (0.06)	11	High	600	Satin or bronzed painted aluminum and brushed finished steel and aluminum, textured plastics.
25A87	Co-Extruded/Acrylic	2.5 (0.06)	13	High	600	Brushed aluminum and stainless. Hand applied to cultured marble (typically dusty surface).
25A88	Co-Extruded/Acrylic	2.5 (0.06)	15	High	600	Matte high-pressure laminates. For matte finished automotive plastic parts.
25A89	Co-Extruded/Acrylic	2.5 (0.06)	15	High	600	For non-UV applications requiring high elongation and excellent abrasion resistance compared to a traditional polyethylene film.
2A804	Co-Extruded/Acrylic	2 (0.05)	2	Very Low	600	Effective in many outdoor applications for up to 3 days.
2A825	Co-Extruded/Acrylic	2 (0.05)	7	Medium	600	Painted building panels. Automotive moldings and urethane fascias.
2A826	Co-Extruded/Acrylic	2 (0.05)	8	Medium	600	Painted, embossed, metal building panels, canopies and molded fiberglass.
2A829	Co-Extruded/Acrylic	2 (0.05)	12	Medium	600	Brushed aluminum. Textured, plastic automotive moldings. Offers excellent protection for mill finished aluminum and steel surfaces.
2A87	Co-Extruded/Acrylic	2 (0.05)	14	High	600	Matte decorative and vinyl laminates.
2A88	Co-Extruded/Acrylic	2 (0.05)	15	High	600	Matte decorative and vinyl laminates. Matte, plastic screen-printed nameplates.
2A89	Co-Extruded/Acrylic	2 (0.05)	15	High	600	Matte decorative and vinyl laminates; brushed and anodized aluminum.
5A829	Co-Extruded/Acrylic	5 (0.13)	10	High	600	Offers superior protection for mill finished aluminum and steel surfaces.
Carpet Tapes						
2E79	Polyethylene/Acrylic	2 (0.05)	20	High	600	Automotive carpeted areas, fabric seals and headliners.
2E93/EZ	Polyethylene/Acrylic	2 (0.05)	25	Very High	600	Automotive carpets, fabric seals and headliners.
2E95/EZ	Polyethylene/Acrylic	2 (0.05)	35	Very High	600	Automotive carpets, fabric seals and headliners.
2E98	Polyethylene/Acrylic	2 (0.05)	45	Very High	600	For marine carpet only.
2E97	Polyethylene/Acrylic	2 (0.05)	35	Very High	600	For automotive and industrial carpets and fabrics only.
4193/EZ	Polyethylene/Acrylic	4 (0.10)	25	Very High	600	Residential carpet tape.
5193EZ	Polyethylene/Acrylic	5 (0.13)	30	Very High	600	Residential carpet tape.
4195/EZ	Polyethylene/Acrylic	4 (0.10)	30	Very High	600	Higher adhesion for treated carpet.
4F94	Polyethylene/Acrylic	4 (0.10)	20	Very High	600	Flame retardant carpet tape
Co-Extruded Tapes						
15CV804	Polyethylene/Acrylic	1.5 (0.04)	2	Very Low	420	LCD screens, glass, polycarbonate, high gloss laminate.
15CV825	Polyethylene/Acrylic	1.5 (0.04)	7	Medium	420	Smooth semi-gloss cultured marble, high pressure laminate.
15CV826	Polyethylene/Acrylic	1.5 (0.04)	8	Medium	420	Smooth, satin gloss cultured marble, high pressure laminate.
Self Sealing Tapes						
3130	Polyethylene/Rubber	3 (0.08)	14*	n/a	450	Cohesive film used to package small machine parts, hand tools and literature.
4130	Polyethylene/Rubber	4 (0.10)	12*	n/a	450	

*Value measured as a cohesive bond strength in units.

Selected tapes are available in transparent, blue, white and black/white. For information regarding available colors, contact Protective Tapes customer service at 1-800-241-2031.

Note: The technical information and data on these pages should be considered representative or typical only and should not be used for specification purposes.

3M™ Protective Tapes (cont.)

Nominal Results

Product	Tape Structure (Backing/Adhesive)	Total Thickness mils (mm)	Adhesion to Steel oz./in. width	Tack Level	Elongation at Break (%)	Application Ideas
Based on ASTM Test Method:		D-3652	D-3330		D-3759	
Laser Tapes						
4H81CPK	Polyolefin/Acrylic	4 (0.10)	12	Medium	270	Designed to be machine laminated using nip roll pressure. For best performance, apply 72 hours before laser cutting.
4H81WPK	Polyolefin/Acrylic	4 (0.10)	12	Medium	270	
4H85CPB	Polyolefin/Acrylic	4 (0.10)	17	High	270	Unique film construction offering extra protection during processing and allowing easy removal.
4H85WPB	Polyolefin/Acrylic	4 (0.10)	17	High	270	
Polyester Tapes						
1614	Polyester/Acrylic	1.3 mil (0.03)	1	Very Low	88	Low tack adhesive removes cleanly after exposures of up to 300°F (150°C).
1675	Polyester/Acrylic	1.3 mil (0.03)	2	Low	88	Low tack adhesive removes cleanly after exposures of up to 350°F (171°C).
Transit Films						
24S56W	Polypropylene/Acrylic	3 (0.08)	9	Medium	700	White tape for painted metals, plastic surfaces and automotive clearcoat paint finishes.
44S56W	Polypropylene/Acrylic	4 (0.10)	9	Medium	800	
64S58W	Polypropylene/Acrylic	6 (0.15)	9	Medium	630	Use on base, clearcoat and high gloss painted surfaces. Ideal for heavy abrasion protection.
UV Tapes						
25M25X	Polypropylene/Acrylic	2.5 (0.06)	6	Medium	600	Black/White tape does not lift and removes cleanly after sunlight exposure.
25M26X	Polypropylene/Acrylic	2.5 (0.06)	8	Medium	600	
25X126	Polypropylene/Acrylic	2.5 (0.06)	6	Medium	850	Can withstand up to 30 days of outdoor exposure in applications oriented at 90 degrees to sunlight.**
2AU23B/UV	Co-extruded A	2 (0.05)	3	Low	600	For glass and window frames with a high-gloss surface, high-gloss painted metals and plastics.
2AU26B/UV	Co-extruded A	2 (0.05)	7	Medium	600	For flat finished vinyl and aluminum window frames, flat finished painted metals and plastics.
31U23/UV	Polyethylene/Acrylic	3 (0.08)	3	Low	450	For glass and window frames with a high-gloss surface, high-gloss painted metals and plastics.
31U26/UV	Polyethylene/Acrylic	3 (0.08)	7	Medium	450	For flat finished vinyl and aluminum window frames, flat finished painted metals and plastics.
31U82P	Polyethylene/Acrylic	2.8 (0.07)	12.5	Medium	450	Protects a variety of automotive wheels.
31U84P	Polyethylene/Acrylic	3.2 (0.08)	15.5	Medium/High	450	
3W25X	Co-Extruded Polyethylene/ Acrylic	3.0 (0.08)	5	Medium	450	Black/White tape does not lift and removes cleanly after exposure to sunlight. Excellent UV resistance for up to 9 months.**
3W26X	Co-Extruded Polyethylene/ Acrylic	3.0 (0.08)	6	Medium	450	
3W29X	Co-Extruded Polyethylene/ Acrylic	3.0 (0.08)	7	Medium	450	
3W55X	Co-Extruded Polyethylene/ Acrylic	3.0 (0.08)	5	Medium	450	

**UV performance was generated from actual exposure in South Eastern USA on selected painted metal surfaces.

Selected tapes are available in transparent, blue, white and black/white. For information regarding available colors, contact Protective Tapes customer service at 1-800-241-2031.



3M™ Protective UV Tapes Black/White feature UV-resistant adhesives with a UV-resistant backing that provide clean removal from substrates from anywhere between 1 to 9 months.



3M™ Clear Laser Tapes are designed to provide temporary protection for a variety of stainless steel finishes during laser cutting and storage.



3M™ Carpet Tapes provide temporary protection of pre-tested treated truck, automotive and other hard-to-adhere carpets, fabrics interiors and carpeted door panels that require very high adhesion levels.

Note: The technical information and data on these pages should be considered representative or typical only and should not be used for specification purposes.

3M™ Protective Tapes (cont.)

Nominal Results

Product	Tape Structure (Backing/Adhesive)	Total Thickness mils (mm)	Adhesion to Steel oz./in. width	Tack Level	Elongation at Break (%)	Application Ideas
Based on ASTM Test Method:		D-3652	D-3330		D-3759	
Polyethylene Tapes						
21804	Polyethylene/Acrylic	2 (0.05)	1	Very Low	450	Glass, CRT screens, LED and LCD screens.
21825	Polyethylene/Acrylic	2 (0.05)	5	Medium	450	Painted, embossed, architectural building panels. Semi-gloss laminates and acrylic sheets.
21826	Polyethylene/Acrylic	2 (0.05)	7	Medium	450	Slightly textured plastics, steel garage doors, metal extrusions and painted building panels.
2187	Polyethylene/Acrylic	2 (0.05)	14	Medium	450	For textured plastics and metals.
3179	Polyethylene/Acrylic	3 (0.08)	20	Very High	450	High-tack adhesive will adhere to most matte textured materials to help reduce rework.
31804	Polyethylene/Acrylic	3 (0.08)	1	Very Low	450	High-gloss coated metals. CRT and LCD screens.
31825	Polyethylene/Acrylic	3 (0.08)	5	Medium	450	Cut-to-length metal sheets in fabrication, shipping and storage. Semi-gloss, painted metals and plastic surfaces.
31826	Polyethylene/Acrylic	3 (0.08)	7	Medium	450	Embossed, painted, metal building panels. Mill-finished aluminum and stainless sheets or coils in fabrication and shipping.
31829	Polyethylene/Acrylic	3 (0.08)	11	Medium-High	450	Painted metal, gloss finish building panels.
3187	Polyethylene/Acrylic	3 (0.08)	11	High	450	Brushed aluminum and stainless. Hand applied to cultured marble (typically dusty surface).
3188	Polyethylene/Acrylic	3 (0.08)	13	High	450	Matte, high-pressure laminates. Matte plastics.
4167	Polyethylene/Acrylic	4 (0.10)	18	High	450	Textured decorative laminates and vinyl. Woodgrain laminates, matte plastics.
4179	Polyethylene/Acrylic	4 (0.10)	20	High	450	Dissimilar metals. Automotive kick plates.
41825	Polyethylene/Acrylic	4 (0.10)	5	Medium	450	Polished #3 and #4 finished stainless coils or sheets.
41826	Polyethylene/Acrylic	4 (0.10)	7	Medium	450	Molded fiberglass or acrylic tubs and spas. Automotive applications such as bumpers, fascias, body side molding paint protection, tail lights or window glass.
4187	Polyethylene/Acrylic	4 (0.10)	13	High	450	Cultured marble and molded fiberglass. Woodgrain vinyl decorative laminates.
4188	Polyethylene/Acrylic	4 (0.10)	15	High	450	Brushed anodized aluminum. Matte plastics or high-pressure laminates.
51825	Polyethylene/Acrylic	5 (0.13)	3	Low	450	Painted metal, gloss finish building panels. Coated metal automotive trim.
51826	Polyethylene/Acrylic	5 (0.13)	5	Medium	450	Mill finish aluminum and stainless coils and sheets. Molded fiberglass, polyester tubs and showers.
5187	Polyethylene/Acrylic	5 (0.13)	10	Medium	450	Cultured marble, textured plastics, matte painted metals.
5188	Polyethylene/Acrylic	5 (0.13)	15	High	450	Cultured marble, textured plastics, matte painted metals.
8179	Polyethylene/Acrylic	8 (0.21)	15	High	450	Dissimilar metals.
Other Protective Tapes						
335/Pink	Polyester/Rubber	1.5 (0.04)	13	Very Low	115	Low tack protective tape.
336/Clear	Polyester/Rubber	1.5 (0.04)	13	Very Low	115	Transparent, low tack protective tape, good attachment to smooth surfaces.
346/Tan	Flat Paper Stock/Rubber	17.0 (0.42)	22	Very High	4	Heavy-duty protective tape.
9343/Black	Nonwoven/Acrylic	19.5 (0.50)	27	Very High	400	Conformable for irregular shaped parts.

Selected tapes are available in transparent, blue, white and black/white. For information regarding available colors, contact Protective Tapes customer service at 1-800-241-2031.

3M™ Preservation Tapes

Product Number	Color	Adhesive Type	Backing Material	Backing Thickness mils (mm)	Total Thickness mils	Adhesion to Steel oz./in. (N/100 mm)	Tensile Strength lb./in. (N/100 mm)	Elongation at Break %	Temperature Range °F (°C)	Comments
481	Black	Rubber	Polyethylene	7.7 (0.20)	9.8	25 (28)	15 (260)	510	20 to 170 (-7 to 76)	Preservation sealing tape. MIL-T-22085 Amend 3, Type IV. Clean removal up to 2 years.
4811	White	Rubber	Polyethylene	7.5 (0.18)	9.5	30 (36)	15 (260)	490	Up to 170 (Up to 77)	Preservation sealing tape. Clean removal up to 1 year.

Note: The technical information and data on these pages should be considered representative or typical only and should not be used for specification purposes.

3M™ Sandblast Stencil Products and Impact Stripping Tapes

Thick, Durable Rubber Backing for Demanding Surface Protection

Combining 34–82 mil thick rubber backing with aggressive pressure sensitive adhesive, these products meet the rigors of two tough masking applications:

3M™ Sandblast Stencil Products

- Rubber backing thickness ranging from 32–40 mils withstand the heavy blasting used to create crisper, deeper images in stone, wood, and other surfaces
- Uniform backing thickness helps ensure efficient plotter cutting
- Clean, visible cut marks reduce picking and weeding time
- Adhesive adheres to numerous surfaces and removes cleanly
- Advanced rubber backing formulation prevents stretching and design distortion

3M™ Impact Stripping Tapes

- Choice of rubber backing for surface protection during media stripping processes

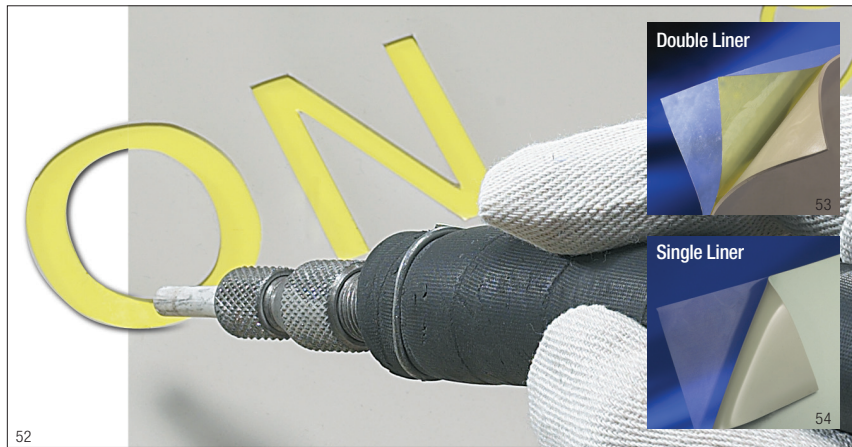

52

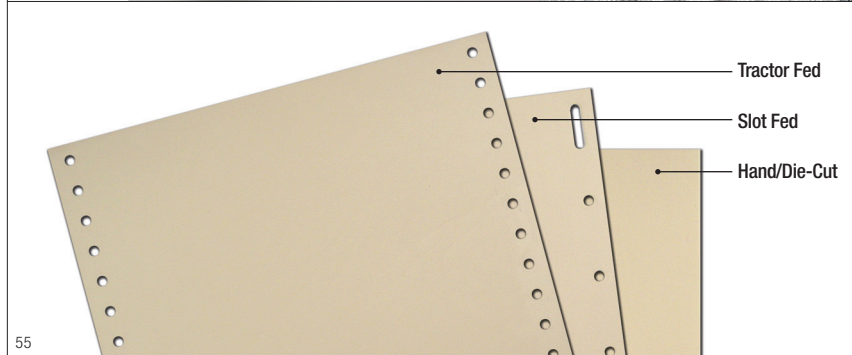

55

For cost-effective production and consistent professional results, 3M Sandblast Stencil products are available with single or double liners for friction, slot and tractor fed plotters as well as hand and die-cutting. Single liners maintain design integrity with either computer or stencil press equipment. Double liners provide support for “islands” eliminating the need for application tape.



Uniform stencil thickness and quality hole punch allow smooth and productive design cutting.



For clean, intricate designs, cut marks are clean and visible for easy and precise picking and weeding.



Easy to see yellow liner, enhances the monument process by providing more precise picking power for greater productivity, blasting accuracy and liner residue cleanup. The advantage of yellow versus a clear liner is especially important when working with intricate details.



3M™ Performance Plus Duct Tape 8979 is ideal for field blasting to help protect surrounding granite surface from blasting impact and rebound damage. Aggressive adhesive stays in place yet removes cleanly without residue.

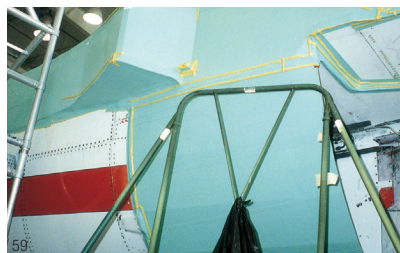

Abrasion-resistant rubber backing and acrylic adhesive of 3M™ Impact Stripping Tapes protect surfaces during plastic media blasting.

3M™ Sandblast Stencil Products and Impact Stripping Tapes

Product Number	Color	Total Thickness (mils)	Adhesive Type	Release Liner Thickness	Release Liner Type	Secondary Liner Thickness	Secondary Liner Type	Product Formats				Adhesion Level	Comments
								Gerber Compatible (Slot Fed)	IBM Compatible (Tractor Fed)	Friction Fed and/or Flatbed	Hand-Cut and/or Die-Cut		
Double Liner													
519Y	Tan	44	Rubber	2.0	Polypropylene	1.5	Polyester		■	■	Medium	Yellow, translucent polyester inner liner, white polypropylene outer liner.	
519YS	Tan	44	Rubber	2.0	Polypropylene	1.5	Polyester	■			Medium		
519YT	Tan	44	Rubber	2.0	Polypropylene	1.5	Polyester		■		Medium		
519YP2	Tan	45	Rubber	2.0	Polyester	1.5	Polyester		■	■	High		
519YP2S	Tan	45	Rubber	2.0	Polyester	1.5	Polyester	■			High		
519YP2T	Tan	45	Rubber	2.0	Polyester	1.5	Polyester		■		High		
519YP	Tan	45	Rubber	4.0	Polyester	1.5	Polyester			■	Medium		
519YPS	Tan	45	Rubber	4.0	Polyester	1.5	Polyester	■			Medium		
519YPT	Tan	45	Rubber	4.0	Polyester	1.5	Polyester		■		Medium		
Single Liner													
507	Green	43	Rubber	2.0	Polyethylene	—	—		■	■	Low	Green, high release liner. Butter cut. Ideal for letter press operations.	
510	Green	43	Rubber	2.0	Polyester	—	—		■	■	Low/Med	Translucent, easy liner release. Use on wood and painted surfaces.	
520	Tan	43	Rubber	2.0	Polyester	—	—		■	■	Med/High	Translucent, high liner release. Best blast resistance for single liner products.	
520S	Tan	43	Rubber	2.0	Polyester	—	—	■			Med/High		
520T	Tan	43	Rubber	2.0	Polyester	—	—		■		Med/High		
520ETL	Tan	43	Rubber	4.0	Polyester	—	—		■	■	Med/High		
1532	Green	34	Rubber	4.0	Polyester	—	—		■	■	Medium	Extra thick, translucent, high liner release. Highest adhesion for single liner products. Excellent for intricate designs. Conformable for use on irregular surfaces.	
1532S	Green	34	Rubber	4.0	Polyester	—	—	■			Medium		
1532T	Green	34	Rubber	4.0	Polyester	—	—		■		Medium		

Product Number	Backing Material	Color	Adhesive Type	Total Thickness mils (mm)	Adhesion to Steel oz./in. (N/100 mm)	Elongation at Break %	Liner Type	Comments
ASTM Test Method				D-3652	D-3330	D-3759		
Impact Stripping Tapes								
500	Rubber	Green	Acrylic	36 (0.9)	29 (31)	85	Paper	Good for small lettering. Acrylic adhesive ideal for use during plastic media blasting.
528	Rubber	Tan	Acrylic	82 (2.1)	29 (31)	145	Paper	Thickest backed sandblast stencil product.

Product Number	Coating Base	Color	Consistency	Available Sizes	Comments
Fillers					
2	Rubber	Light Beige	Syrupy	Quart, Gallon	Designed for smooth and polished surfaces. More aggressive than filler #3.
3	Rubber	Light Beige	5 times more viscous than filler #2	Gallon	Typically used on axed or frosted surfaces.

Note: The technical information and data on these pages should be considered representative or typical only and should not be used for specification purposes.



Specialty Tapes

Selection Simplicity

Wide Variety of Applications

With more than 120 product solutions, the portfolio of 3M™ Specialty Tapes presents customers with numerous characteristics to evaluate in making the optimum choice for an application.

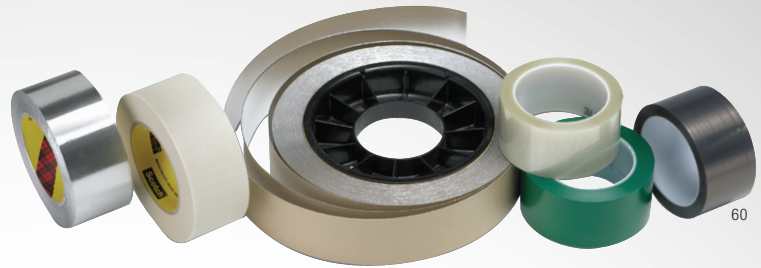

3M™ Specialty Tapes

To help simplify and streamline the selection process, six products have been highlighted for their versatility. **These Specialty Six solve 80% of customer application needs.** The six represent the key backings that comprise much of the 3M™ Specialty Tapes line: glass cloth, metal foil, polyester, slick surface (PTFE), and vinyl.

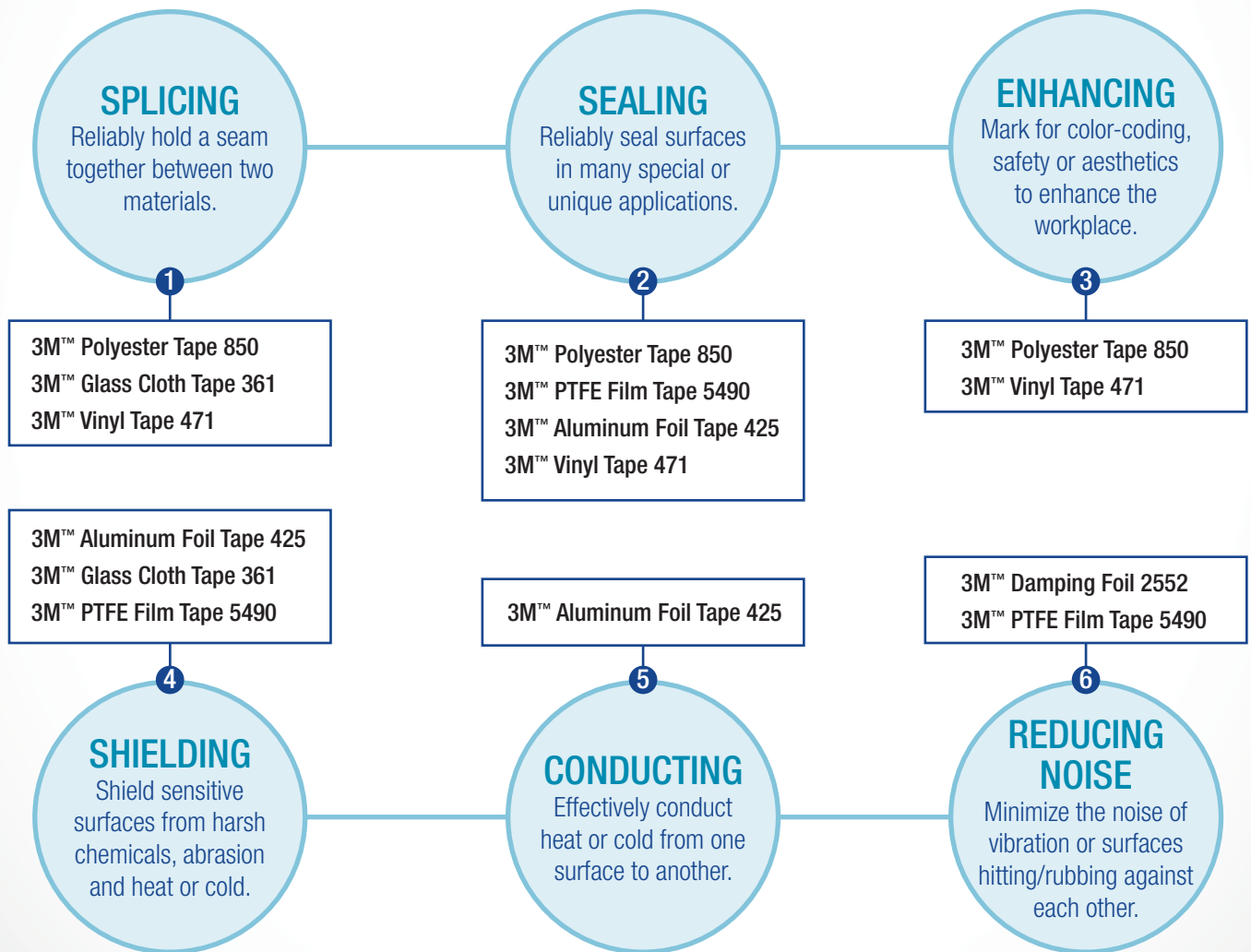

Specialty Tapes

For custom tape solutions, contact a 3M Sales Specialist at 1-800-362-3550.

3M™ Application Specific Tapes

Variety for Many Process and Design Solutions

With a choice of unique backing and adhesive combinations, this engineered line meets demanding applications for aerospace, graphic arts, electronics, metal finishing, automotive and more.

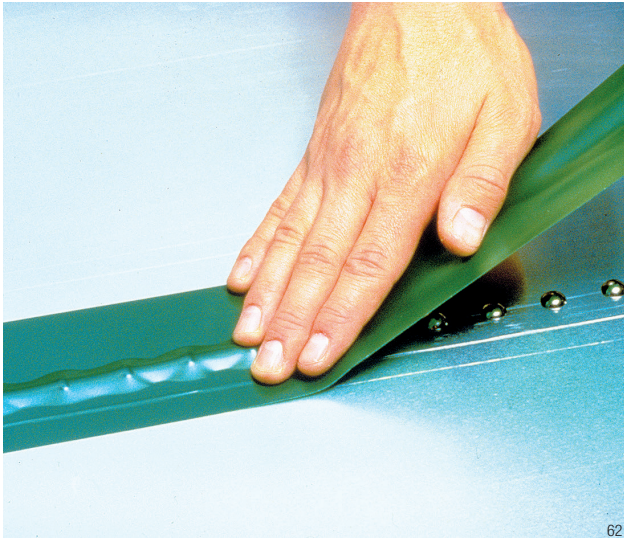

3M™ Riveters Tape is used during riveting to help ensure easy visibility of rivets and no adhesive transfer to rivet heads.



3M™ All Weather Flashing Tape 8067 is a self-adhered, waterproof flashing membrane designed for sealing around openings and penetrations in exterior walls.



Use 3M™ Construction Seaming Tape 8087 for exterior and interior seam, seal, splice and repair applications.

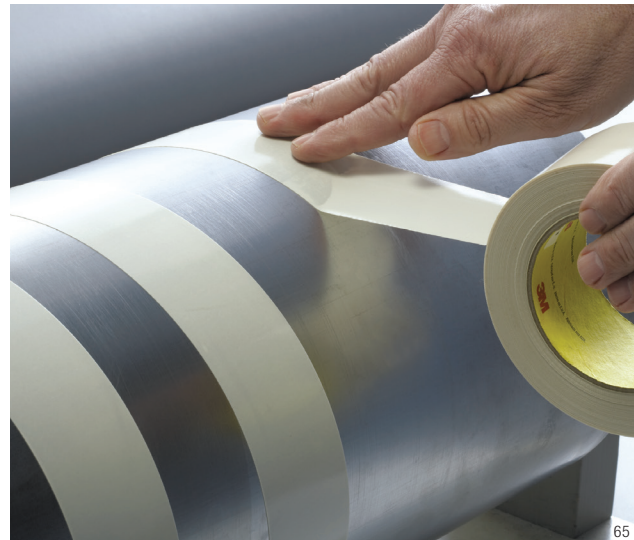

3M™ Traction Tape 5401 enhances friction on web rollers to help maintain constant traction and tension for the web material from start-up through wind-up.

3M™ Application Specific Tapes

Product Number	Color	Adhesive Type	Backing Material	Backing Thickness mils (mm)	Liner Type	Total Thickness mils (mm)	Adhesion to Steel oz./in. (N/100 mm)	Tensile Strength lb./in. (N/100 mm)	Elongation at Break %	Temperature Range °F (°C)	Comments
ASTM Test Method				D-3652		D-3652	D-3330	D-3759	D-3759		
Graphic Arts Tapes											
235	Black	Rubber	Crepe Paper	5.0 (0.12)	—	7.0 (0.17)	23 (25)	22 (386)	9	Up to 200 (Up to 93)	Photographic masking.
616	Ruby Red	Rubber	UPVC	1.6 (0.04)	—	2.4 (0.06)	36 (39)	29 (509)	50	Up to 120 (Up to 49)	Lithographers tape.
3051	White	Acrylic	Flatback Paper	3.4 (0.09)	—	3.8 (0.10)	4 (4)	39 (680)	2	Up to 150 (Up to 65)	Very low tack.
High Temperature Tapes											
8997/8997L	Amber	Silicone	Polyimide	1.0 (0.02)	Polyester	2.2 (0.06)	22 (24)	26 (453)	37	Up to 500 (Up to 260)	Transparent film. High temperature applications. 8997L is lined version.
8998/8998L	Amber	Silicone	Polyimide	2.0 (0.05)	Polyester	3.3 (0.08)	19 (20)	55 (963)	49	Up to 500 (Up to 260)	Transparent film. High temperature applications. 8998L is lined version.
Riveters Tapes											
685	Green	Rubber strip coated along edges of tape only	Polyester	1.0 (0.02)	—	1.7 (0.04)	30 (33)	19 (330)	28	-20 to 150 (-29 to 66)	Transparent film. Green adhesive.
695	Yellow	Acrylic strip coated along edges of tape only	Polyethylene	2.0 (0.05)	—	3.0 (0.08)	15 (16)	8 (140)	120	-20 to 120 (-29 to 49)	Yellow film. White adhesive.
Venting Tapes											
394	White	Acrylic	Non-Woven	4.5 (0.11)	—	5.0 (0.13)	12 (13)	6 (100)	18	Up to 120 (Up to 49)	Air-permeable backing.
3294	Pink	Acrylic	Non-Woven	4.5 (0.11)	—	5.0 (0.13)	9 (10)	8 (140)	15	Up to 120 (Up to 49)	Most permeable venting tape. Strip coated.
Nylon Tapes											
855	White	Rubber	Nylon	2.0 (0.05)	—	3.2 (0.08)	55 (60)	31 (540)	470	60 to 400 (16 to 204)	Composite bonding tape.
8555	White	Rubber	Nylon	5.0 (0.13)	—	6.0 (0.15)	60 (66)	69 (1208)	540	60 to 400 (16 to 204)	Thick version of 855 tape.
Construction Tapes											
8067	Tan	Acrylic	Multi-Layer Elastomeric Film	5.0 (0.13)	Polycoated Kraft Paper	10.0 (0.25)	60 (66)	20 (350)	700	Up to 176 (Up to 80)	Window and door flashing tape. Meets ICC AC 148, AAMA 711 specs.
8087	Red	Acrylic	Biaxially Oriented Polypropylene Film	1.5 (0.04)	—	3.0 (0.08)	45 (49)	20 (350)	130	Up to 220 (Up to 104)	Construction seaming tape.
Other Specialty Tapes											
253	Tan	Silicone	Treated Flatsstock Paper	3.5 (0.09)	Modified Poly Liner	4.6 (0.12)	49 (54)	60 (1052)	3	50 to 150 (10 to 66)	Silicone butt splicing tape.
346	Tan	Rubber	Flat Paper Stock	15.0 (0.38)	—	16.7 (0.42)	22 (24)	28 (490)	4	60 to 100 (16 to 38)	Heavy-duty abrasion, moisture, UV protection.
838	White	Acrylic	PVF	2.1 (0.05)	—	3.4 (0.09)	47 (51)	24 (420)	170	100 to 225 (38 to 107)	Weather resistant film tape.
5401	Tan	Silicone	Fiberglass Reinforced Silicone	8.0 (0.20)	—	9.3 (0.24)	12 (13)	220 (3853)	7	Up to 300 (Up to 148)	High coefficient of friction for traction.
5461	White	Rubber	Silicone Rubber	7.8 (0.19)	Silicone-Paper	9.1 (0.23)	30 (33)	85 (1500)	165	Up to 200 (Up to 93)	High friction roller tape.
8777	Tan	Acrylic	Multi-Layer Elastomeric Film	5.0 (0.13)	Polycoated Kraft Paper	10.0 (0.25)	60 (66)	20 (350)	700	Up to 176 (Up to 80)	Air and water tight sealing tape.
9343	Black	Acrylic	Non-Woven	14.5 (0.37)	Paper	19.5 (0.50)	27 (30)	5 (88)	400	Up to 250 (Up to 121)	Conformable for irregular parts.

Note: The technical information and data on these pages should be considered representative or typical only and should not be used for specification purposes.

3M™ Glass Cloth Tapes

High Tensile Strength with Choice of Other Properties

With a choice of high tensile strength glass cloth and silicone, acrylic, or rubber adhesives, this line meets demanding applications for Aerospace, Automotive, Commercial Vehicle, Construction, Marine and more.

Depending on the specific tape, you have a choice of characteristics:

- Pass FAA flame resistance regulations
- Protect surfaces against abrasion
- Temperature resistance up to more than 450°F (232°C) for one hour — even higher for intermittent exposures



For seaming and sealing panels in aircraft cargo bays, 3M™ Glass Cloth Tape 398FR exceeds flame retardant standards F.A.R. 25.853 (a) and F.A.R. 25.855 (d). Pressure sensitive acrylic adhesive bonds on contact to many surfaces. High adhesion is secure for extended periods. Rugged cloth surface resists wear from heavy bags.

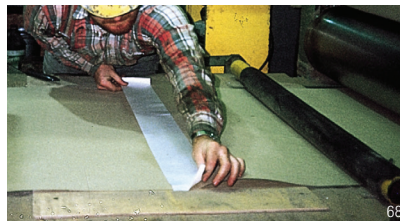

With high tensile strength and rubber adhesive, 3M™ Glass Cloth Tape 365 reliably splices fabrics and other textured surfaces.

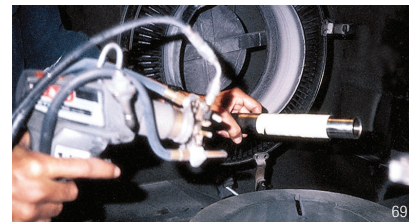

For thermal spray and plasma spray masking, 3M™ Glass Cloth Tape 361 with silicone adhesive performs reliably at up to 450°F (232°C). Passes FAA flame resistance regulations.

Product	Color	Adhesive Type	Backing Material	Backing Thickness mils (mm)	Liner Type	Total Thickness mils (mm)	Adhesion to Steel oz/in (N/100 mm)	Tensile Strength lb/in (N/100 mm)	Elongation at Break %	Temperature Range °F (°C)	Meets Specifications	Comments
Based on ASTM Test Method:				D-3652		D-3652	D-3330	D-3759	D-3759			
361	White	Silicone	Glass Cloth	5.0 (0.13)	—	6.4 (0.16)	38 (42)	146 (2555)	10	-65 to 450 (-54 to 232)	F.A.R. 25.853	General purpose glass cloth tape.
3615	White	Silicone	Glass Cloth	5.0 (0.13)	—	7.0 (0.18)	35 (38)	180 (3140)	7	-65 to 450 (-54 to 232)	—	General purpose glass cloth tape.
365	White	Thermoset Rubber	Glass Cloth	4.8 (0.12)	—	8.3 (0.20)	52 (57)	139 (2430)	7	40 to 450 (4 to 232)	—	Splicing textured surfaces. Thermosetting adhesive.
3650	White	Thermoset Rubber	Glass Cloth	4.8 (0.12)	Blue Film	8.3 (0.20)	52 (57)	139 (2430)	7	40 to 450 (4 to 232)	—	Lined version of 365. Thermosetting tape.
398FR	White	Acrylic	Glass Cloth	5.0 (0.13)	Blue Film	7.0 (0.18)	38 (42)	130 (2276)	7	-20 to 250 (-29 to 121)	BMS 5-146; F.A.R. 25.853(a); F.A.R. 25.855(d)	Skip-slit liner for ease of application.
398FRP	White	Acrylic	Glass Cloth	5.0 (0.13)	Blue Film	7.0 (0.18)	38 (42)	130 (2276)	7	-20 to 250 (-29 to 121)	BMS 5-146; F.A.R. 25.853(a); F.A.R. 25.855(d)	Printed backing version of 398FR.
399FR	White	Acrylic	Glass Cloth	5.0 (0.13)	Blue Film	9.5 (0.24)	52 (57)	130 (2276)	7	-20 to 200 (-29 to 93)	F.A.R. 25.853(a)	Thicker adhesive. Flame resistant.

Note: The technical information and data on these pages should be considered representative or typical only and should not be used for specification purposes.

3M™ Metal Foil Tapes

Choice of High Performance Foil Tapes

With a choice of conformable backings and adhesives, this line of tapes meets demanding applications in Aerospace, Appliance, Transportation, Construction, Automotive, and MRO (Maintenance and Repair) segments.

3M™ Aluminum Foil Tapes

- Resist flame, moisture, weather, UV degradation and most chemicals
- Thermally conductive for heating and cooling efficiency
- Heat and light reflective

3M™ Aluminum Foil Reinforced Tapes

- Flexible flame-resistant wrap for wires and hoses
- Long wearing, tear and puncture resistant
- Flame and heat resistant

3M™ Lead Foil Tapes

- Electrically conductive
- Acid resistant for plating masking
- Radiopaque for X-ray markers

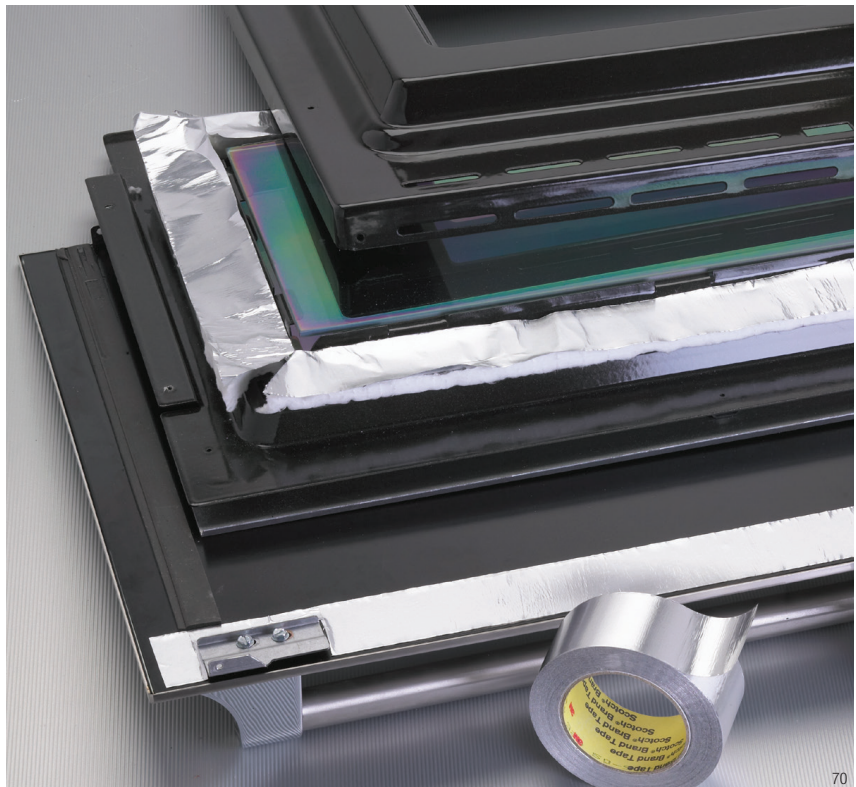

3M™ Aluminum Foil Tape bonds on contact as heat shielding inside an oven door. Helps keep the exterior cool to the touch behind the handle and around the window perimeter.



With aggressive adhesive and dead soft aluminum, Scotch® Foil Tape 3311 seals and secures seams and joints for long-term durability. UL 723 listed for duct sealing and general repairs.

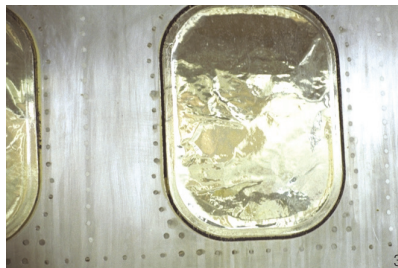

With conformability and chemical resistance, 3M™ Aluminum Foil Tapes protect aircraft windows during harsh chemical paint stripping.



With high heat reflectivity and thermal conductivity, 3M™ Aluminum Foil Tapes protect heat-sensitive components near lights in a garage door opener housing.

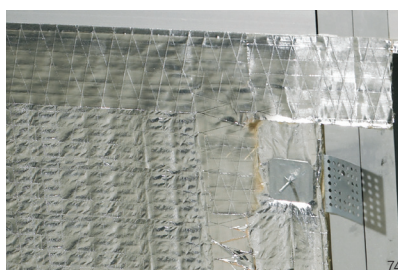

3M™ FSK Facing Tape 3320 is engineered specifically as a vapor retardant tape to seal mineral wool foil-faced insulation, bare sheet metal ducts and blanket style fiberglass duct insulation.



Tear-resistant 3M™ Reinforced Aluminum Foil Tape 363 bundles wire harnesses and helps protect wires, cables, and other flexible parts from heat.

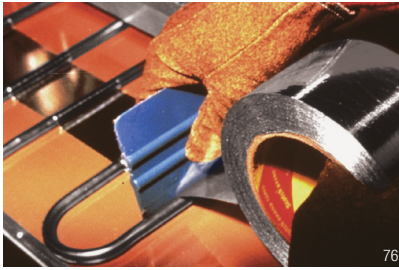

Conformable 3M™ Aluminum Foil Tape securely holds copper cooling tubes to refrigerator panels. Thermal conductivity helps maximize cooling efficiency.



To seal fiberglass duct board and flexible duct systems, Scotch® Foil Tape 3326 meets the performance requirements for UL 181A-P and UL 181B-FX.

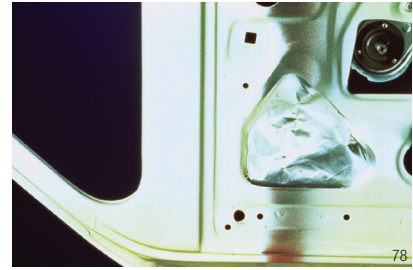

Applied over holes and cavities in the interior of a car or truck door panel, 3M™ Aluminum Foil Tape seals out moisture and dust.

3M™ Metal Foil Tapes

Product Number	Color	Adhesive Type	Backing Material	Backing Thickness mils (mm)	Liner Thickness mils (mm)	Liner Type	Total Thickness mils (mm)	Adhesion to Steel oz./in. (N/100 mm)	Tensile Strength lb./in. (N/100 mm)	Elongation at Break %	Meets Specifications	Temperature Range °F (°C)	Comments
ASTM Test Method				D-3652			D-3652	D-3330	D-3759	D-3759			
Premium Performance													
425	Silver	Acrylic	Aluminum Foil	2.8 (0.07)	—	—	4.6 (0.12)	47 (51)	28 (490)	6	F.A.R. 25.853(a); SAE AMS T-23397; UL 723; UL 746C; LT-80 C	-65 to 300 (-54 to 149)	Most versatile aluminum tape.
427	Silver	Acrylic	Aluminum Foil	2.8 (0.07)	3.1 (0.08)	Easy Release Film	4.6 (0.12)	50 (55)	28 (490)	6	F.A.R. 25.853(a); UL 723; UL 746C; LT-80 C	-65 to 300 (-54 to 149)	Lined version of 425.
431	Silver	Acrylic	Aluminum Foil	1.9 (0.05)	—	—	3.1 (0.08)	34 (37.3)	17 (302)	3	F.A.R. 25.853(a)	-65 to 300 (-54 to 149)	Conformable aluminum tape.
433	Silver	Silicone	Aluminum Foil	2.0 (0.05)	—	—	3.6 (0.09)	40 (43.8)	20 (350)	3.5	F.A.R. 25.853(a); US Gov A-A-59258	-65 to 300 (-54 to 149)	Silicone adhesive for high temperature resistance. Smooth, easy unwind, clean, straight edges with minimal wrinkling.
433L	Silver	Silicone	Aluminum Foil	2.0 (0.05)	3.2 (0.08)	Easy Release Film	3.5 (0.09)	38 (42.0)	20 (350)	3.5	F.A.R. 25.853(a)	-65 to 600 (-40 to 316)	Lined version of 433.
437	Silver	Acrylic	Aluminum Foil	2.8 (0.07)	4.2 (0.11)	Easy Release Film	8.0 (0.20)	150 (164)	30 (525)	8	—	-40 to 212 (-40 to 100)	Dead-soft aluminum foil tape.
438	Silver	Acrylic	Aluminum Foil	5.0 (0.13)	—	—	7.2 (0.18)	43 (47)	59 (1033)	10	F.A.R. 25.853(a)	-65 to 300 (-54 to 149)	Thickest non-reinforced aluminum tape for heat resistance. Smooth, easy unwind, clean, straight edges with minimal wrinkling.
438L	Silver	Acrylic	Aluminum Foil	5.0 (0.13)	2.5 (0.06)	Easy Release Film	7.2 (0.18)	43 (47)	59 (1033)	10	F.A.R. 25.853(a)	-65 to 300 (-54 to 149)	
439	Silver	Acrylic	Aluminum Foil	1.9 (0.05)	5.7 (0.14)	Kraft Paper with Silicone Release	3.1 (0.08)	34 (37.3)	17 (302)	3	F.A.R. 25.853(a)	-65 to 300 (-54 to 149)	Lined version of 431.
3338	Silver	Acrylic	Aluminum Foil	5.0 (0.13)	5.0 (0.13)	Polycoated Kraft Paper Release	7.0 (0.18)	45 (49)	50 (876)	21	—	-65 to 300 (-54 to 149)	66 lb. moisture stable liner.
33801	Silver	Acrylic	Aluminum Foil	2.0 (0.05)	5.0 (0.13)	Polycoated Kraft Paper	4.0 (0.10)	40 (43.8)	20 (350)	5	UL 723	-30 to 425 (-34 to 218)	High temperature acrylic adhesive.
33806	Silver	Acrylic	Aluminum Foil	3.0 (0.076)	5.2 (0.13)	Polycoated Kraft Paper	5.0 (0.13)	95 (105)	30 (525)	6	—	-40 to 425 (-40 to 218)	High temperature acrylic adhesive.

Note: The technical information and data on these pages should be considered representative or typical only and should not be used for specification purposes.

3M™ Metal Foil Tapes (cont.)

Product Number	Color	Adhesive Type	Backing Material	Backing Thickness mils (mm)	Liner Thickness mils (mm)	Liner Type	Total Thickness mils (mm)	Adhesion to Steel oz./in. (N/100 mm)	Tensile Strength lb./in. (N/100 mm)	Elongation at Break %	Meets Specifications	Temperature Range °F (°C)	Comments
ASTM Test Method				D-3652		D-3652		D-3330	D-3759	D-3759			
General Purpose													
3311*	Silver	Rubber	Aluminum Foil	2.0 (0.05)	2.0 (0.05)	Paper	3.6 (0.09)	90 (98)	17 (298)	3	UL 723	-10 to 180 (-23 to 82)	Designed for maximum adhesion over clean, dry surfaces.
3369	Silver	Acrylic	Aluminum Foil	1.1 (0.028)	3.2 (0.08)	Polycoated Natural Kraft Paper	2.4 (0.06)	58 (64)	11 (197)	2	UL 723	-40 to 250 (-40 to 121)	Thinnest aluminum foil tape.
33803	Silver	Rubber	Aluminum Foil	1.8 (0.05)	3.6 (0.09)	Polycoated Kraft Paper	3.6 (0.09)	90 (99)	15 (263)	4	UL 723	0 to 175 (-18 to 79)	Highest tack rubber adhesive.
97065	Silver	Acrylic	Aluminum Foil	1.8 (0.05)	5.2 (0.13)	Polycoated Kraft Paper	3.4 (0.09)	48 (53)	18 (315)	3	—	-40 to 250 (-40 to 121)	Good for die-cut applications.
3380	Silver	Acrylic	Aluminum Foil	2.0 (0.05)	3.2 (0.08)	Natural Kraft Paper	3.3 (0.08)	40 (43.8)	10 (175)	4	UL 723	-30 to 260 (-34 to 121)	Good for narrow slit rolls.
4380	Silver	Acrylic	Aluminum Foil	2.0 (0.05)	—	—	3.3 (0.08)	40 (43.8)	10 (175)	4	—	-30 to 300 (-34 to 149)	General purpose aluminum foil tape.
34383	Silver	Acrylic	Aluminum Foil	2.8 (0.07)	—	—	4.5 (0.11)	55 (61)	30 (542)	11	—	-40 to 300 (-40 to 149)	General purpose aluminum foil tape.
3363	Silver	Acrylic	Aluminum Foil	3.0 (0.08)	3.2 (0.08)	Polycoated Natural Kraft Paper	5.0 (0.13)	40 (43.8)	28 (490)	6	UL 723	-40 to 250 (-40 to 121)	Good for narrow slit rolls.
3367	Silver	Acrylic	Aluminum Foil	3.0 (0.08)	5.2 (0.13)	Polycoated Kraft Paper	4.4 (0.11)	48 (53)	30 (525)	6	UL 723	-40 to 250 (-40 to 121)	Good for die-cut applications.
Lead Foil													
420	Dark Silver	Rubber	Lead Foil	4.7 (0.12)	3.5 (0.09)	Easy Release Film	6.8 (0.17)	45 (49)	20 (350)	12	—	-60 to 225 (-51 to 107)	Lined plating tape.
421	Dark Silver	Rubber	Lead Foil	4.0 (0.10)	—	—	6.3 (0.16)	31 (34)	15 (263)	14	—	-60 to 225 (-51 to 107)	Self-wound plating tape.
4201	Dark Silver	Acrylic	Lead Foil	5.0 (0.13)	5.0 (0.13)	Polycoated Natural Kraft Paper	6.5 (0.17)	40 (43.8)	20 (350)	5	—	-30 to 225 (-34 to 121)	Permanent acrylic adhesive.
34201	Dark Silver	Rubber	Lead Foil	5.0 (0.13)	5.3 (0.13)	Polycoated Natural Kraft Paper	6.3 (0.16)	50 (55)	20 (350)	5	—	0 to 180 (-18 to 82)	Removable rubber adhesive.
Copper Foil													
3313	Copper	Conductive Acrylic	Copper Foil	1.4 (0.04)	4.3 (0.11)	Glassine Paper	3.0 (0.08)	29 (32)	25 (444)	3	UL 510	-40 to 250 (-40 to 121)	EMI/RFI shielding.
3325	Copper	Acrylic	Copper Foil	1.5 (0.04)	5.0 (0.13)	Polycoated Natural Kraft Paper	3.0 (0.08)	40 (43.8)	28 (491)	10	UL 510	0 to 225 (-18 to 107)	EMI/RFI shielding.
33315	Copper	Acrylic	Copper Foil	1.5 (0.04)	5.0 (0.13)	Natural Kraft Paper	3.3 (0.08)	35 (39)	28 (491)	5	—	-30 to 300 (-34 to 149)	"Tinned", corrosion resistant.
33316	Copper	Conductive Acrylic	Copper Foil	1.5 (0.04)	4.0 (0.10)	Glassine Paper	3.0 (0.08)	30 (33)	33 (578)	6	UL 510	0 to 250 (-18 to 121)	"Tinned", corrosion resistant.
Stainless Steel Foil													
3361	Silver	Acrylic	Stainless Steel	2.0 (0.05)	4.6 (0.12)	Polycoated Kraft Paper	3.8 (0.10)	40 (43.8)	100 (1751)	40	—	-30 to 250 (-34 to 121)	Corrosion resistant.

*Scotch® Tape brand.

Note: The technical information and data on these pages should be considered representative or typical only and should not be used for specification purposes.

3M™ Metal Foil Tapes (cont.)

Product Number	Color	Adhesive Type	Backing Material	Backing Thickness mils (mm)	Liner Thickness mils (mm)	Liner Type	Total Thickness mils (mm)	Adhesion to Steel oz./in. (N/100 mm)	Tensile Strength lb./in. (N/100 mm)	Elongation at Break %	Meets Specifications	Temperature Range °F (°C)	Comments
ASTM Test Method				D-3652			D-3652	D-3330	D-3759	D-3759			
Specialty Foil													
363	Silver	Silicone	Aluminum Foil Laminated to Glass Cloth	3.4 (0.086)	—	—	7.3 (0.19)	52 (57)	135 (2364)	7	F.A.R. 25.853(a)	-65 to 600 F (-54 to 316 C)	Aluminum foil/glass cloth. Highest temperature metal foil tape.
363L	Silver	Silicone	Aluminum Foil Laminated to Glass Cloth	3.4 (0.086)	3.0 (0.08)	Easy Release Film	7.3 (0.19)	52 (57)	135 (2364)	7	F.A.R. 25.853(a)	-65 to 600 F (-54 to 316 C)	Lined version of 363.
1430	Silver	Acrylic	Aluminum Foil Non-Woven Web	5.0 (0.13)	—	—	5.5 (0.14)	22 (24)	19 (333)	12	—	-65 to 300 F (-54 to 106 C)	Aluminum foil/non-woven laminate. Flexible wrapping tape.
3302	Silver	Conductive Acrylic	Aluminum Foil	2.0 (0.05)	4.3 (0.11)	Glassine Paper	3.5 (0.09)	30 (33)	19 (340)	3	UL 510	-40 to 250 F (-40 to 121 C)	Aluminum foil tape. EMI/RFI shielding.
3334	Silver	Acrylic	Aluminum Foil/Scrim/Polypropylene	5.4 (0.14)	3.5 (0.09)	Bleached Glassine Paper	6.9 (0.18)	31 (33.9)	25 (439)	7	—	-10 to 175 F (-23 to 79 C)	Works well in very cold and hot temperatures.
HVAC Construction													
3320	Silver	Acrylic	Aluminum Foil	6.0 (0.16)	4.0 (0.10)	Poly Coated Kraft	6.7 (0.17)	81 (89)	40 (712)	2	UL 723	-20 to 175 (-29 to 79)	Aluminum foil/scrim/laminate.
3340	Silver	Acrylic	Aluminum Foil	2.0 (0.05)	3.5 (0.09)	Paper	4.0 (0.10)	30 (33)	20 (350)	4	UL 181A-P; UL 181B-FX	-30 to 250 (-34 to 121)	Aluminum foil tape for use with rigid and flexible ducts.
3350	Silver	Acrylic	Silver Polypropylene Film	1.6 (0.04)	—	—	3.1 (0.08)	33 (36)	36 (631)	170	UL 181B-FX	-30 to 230 (-34 to 110)	Polypropylene tape for use with flexible ducts.
3380	Silver	Acrylic	Aluminum Foil	2.0 (0.05)	3.2 (0.08)	Natural Kraft Paper	3.3 (0.08)	40 (43.8)	10 (175)	4	UL 723	-30 to 260 (-34 to 121)	General purpose aluminum foil tape. Go-to product for this market.
3381	Silver	Acrylic	Aluminum Foil	1.4 (0.04)	3.2 (0.08)	Natural Kraft Paper	2.7 (0.07)	40 (43.8)	10 (180)	5	UL 723	-30 to 260 (-34 to 121)	Value grade aluminum foil tape.
3382	Silver	Acrylic	Aluminum Foil	2.5 (0.06)	5.2 (0.13)	PE Coated Kraft	4.2 (0.11)	50 (55)	30 (525)	25	—	-40 to 300 (-40 to 149)	Foil/PET laminate, tear resistance. Roof and gutter repair tape.

Note: The technical information and data on these pages should be considered representative or typical only and should not be used for specification purposes.

3M™ Sound Damping Foils

Reduce Noise and Vibration in Many Applications

With pressure sensitive viscoelastic acrylic polymer on dead soft aluminum foil, 3M™ Sound Damping Foils quiet noise and reduce vibration in many areas for Aerospace, Automotive, Appliances, Construction and MRO (Maintenance and Repair).

- Reduce structure-borne noise in metal and composite panels and support structures
- Optimized acrylic converts vibrational energy to negligible heat that readily dissipates
- Reduce vibrational fatigue to decrease wear and tear on parts and lower the risk of part loosening and displacement
- Effective damping with as little as 10% surface coverage
- Pressure sensitive for easy self-fixturing application
- Long aging performance
- Good performance over a wide temperature range
- Lined construction provides ability to die-cut product



Applied with a 3M™ PA-1 Wiper to the inside of a car door, 3M™ Damping Foil 2552 effectively damps noise and vibration with as little as 10% surface coverage. Optimized acrylic on a dead soft aluminum constraining layer converts vibrational energy to negligible heat that readily dissipates.



3M™ Damping Foil 435 between the ribs and stringers of an aircraft fuselage helps reduce vibrational fatigue and noise inside the passenger cabin.

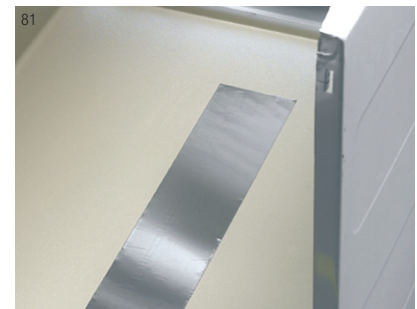

3M™ Damping Foil 2552 on the inside of a washing machine reduces structure-borne noise and reduces vibrational fatigue to decrease the risk of part loosening and displacement.

Product Number	Color	Adhesive Type	Backing Material	Backing Thickness mils (mm)	Liner Type	Total Thickness mils (mm)	Adhesion to Steel oz./in. (N/100 mm)	Tensile Strength lb./in. (N/100 mm)	Elongation at Break %	Temperature Range °F (°C)	Meets Specifications	Comments
ASTM Test Method				D-3652		D-3652	D-3330	D-3759	D-3759			
434	Silver	Viscoelastic Polymer	Aluminum Foil	5.5 (0.14)	Polyethylene	7.5 (0.19)	65 (71.2)	50 (876)	12	-76 to 68 (-60 to 20)	F.A.R. 25.853(a)	Low temperature vibration damping.
435	Silver	Viscoelastic Polymer	Aluminum Foil	8.0 (0.2)	Polyethylene	13.5 (0.34)	65 (71.2)	50 (876)	12	-76 to 68 (-60 to 20)	F.A.R. 25.853(a)	Low temperature vibration damping.
436	Silver	Viscoelastic Polymer	Aluminum Foil	12.0 (0.31)	Polyethylene	17.5 (0.44)	65 (71.2)	50 (876)	12	-76 to 68 (-60 to 20)	F.A.R. 25.853(a)	Low temperature vibration damping.
2542	Silver	Viscoelastic Polymer	Aluminum Foil	5.0 (0.13)	Polyethylene	10.0 (0.25)	65 (72)	63 (1102)	7	-25 to 175 (-32 to 80)	—	Thinner general purpose vibration damping.
2552	Silver	Viscoelastic Polymer	Aluminum Foil	10.0 (0.25)	Polycoated Paper	15.0 (0.38)	65 (72)	126 (2205)	12	-25 to 175 (-32 to 80)	ASTM E756-83	General purpose vibration damping.
4014	Silver	Viscoelastic Polymer	Aluminum-Urethane	3.0 (0.09)	Easy Release Film	250.0 (6.35)	n/a	n/a	90	-94 to 86 (-70 to 30)	F.A.R. 25.853(a)	Foil/foam sheet laminate.

Note: The technical information and data on these pages should be considered representative or typical only and should not be used for specification purposes.

3M™ Polyester Tapes

Thin Caliper with Long-Term High Dimensional Strength

With a choice of thin backing calipers and adhesives, this line of tapes meets demanding applications for Graphic Arts, Photography, Metal Finishing and Electronics. Applications range from splicing silicone-treated paper to low profile decorative trim.

- Backing calipers from as thin as 0.9 mil up to 5 mils, all with very high dimensional strength
- Tensile strengths ranging from 20 lbs./in. (0.9 mil) to 140 lbs./in. (5 mils) — some of the strongest backings available
- Pressure sensitive acrylic, rubber, silicone and S/R blend adhesives to meet specific requirements. For example, acrylic with transparent backing for clarity and long-term holding; silicone for high temperatures and clean removal; rubber for quick adhesion to low surface energy materials

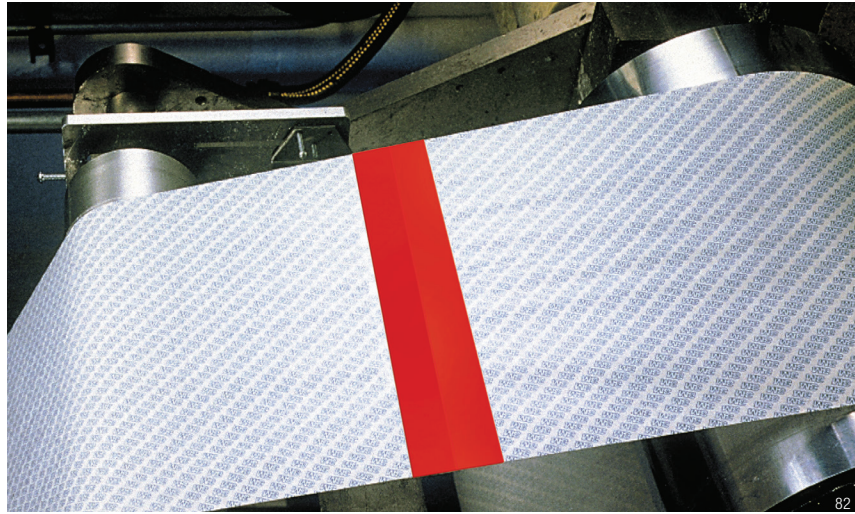

For marking splice location, 3M™ Polyester Tape 850 is available in red, black, white and silver. Transparent is also available to blend with the web stock. Pressure sensitive acrylic adhesive grabs on contact and holds butt splices securely. High tensile strength backing resists web handling stresses.

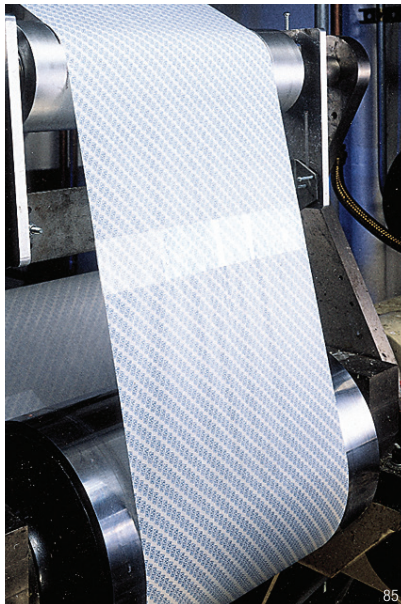

For butt splices on many low surface energy materials such as polyethylene, 3M™ Super Bond Film Tape 396 provides the thin caliper tensile strength of polyester, and high immediate holding strength of rubber adhesive.

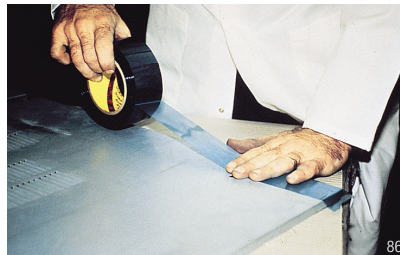

For powder coat paint masking, 3M™ Polyester Tape series 8900 provides popular choices with clean removing high temperature silicone adhesives and different backing thicknesses of tough non-slivering polyester.



With thin caliper and tear resistance, 3M™ Polyester Tape provides tough low-profile reinforcement for punch holes in card stock. Acrylic adhesive resists yellowing in long-term use.

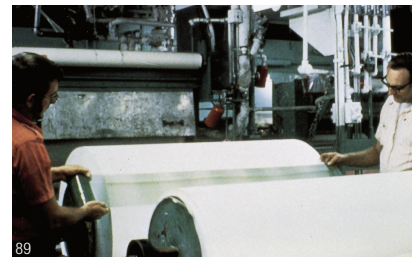

With thin caliper, high tensile strength polyester backing and the excellent shear strength of silicone adhesive, 3M™ Polyester Tape 8402 works well for butt splicing silicone-treated papers.

3M™ Polyester Tapes

Product	Color	Adhesive Type	Backing Material	Backing Thickness mils (mm)	Total Thickness mils (mm)	Adhesion to Steel oz/in (N/100 mm)	Tensile Strength lb/in (N/100 mm)	Elongation at Break %	Temperature Range °F (°C)	Comments
Based on ASTM Test Method:				D-3652	D-3652	D-3330	D-3759	D-3759		
General Industrial Tapes										
396	Transparent	Rubber	Polyester	1.7 (0.04)	4.1 (0.10)	140 (153)	43 (753)	140	40 to 200 (4 to 93)	Adhesion to low surface energy materials.
850	Various	Acrylic	Polyester	0.9 (0.02)	1.9 (0.05)	30 (33)	28 (491)	120	-60 to 300 (-50 to 150)	Splicing, holding, sealing. Transparent, Red, Black, White.
853	Transparent	Acrylic	Polyester	1.1 (0.03)	2.2 (0.06)	46 (50)	25 (434)	83	-60 to 300 (-50 to 150)	L-T-100 F.A.R. 25.853(a)
856	Transparent	Acrylic	Polyester	1.0 (0.03)	2.0 (0.05)	20 (22)	25 (438)	90	-60 to 300 (-50 to 150)	Label protection. Edge and hole reinforcing.
8411	Transparent	Acrylic	Polyester	1.0 (0.03)	1.5 (0.04)	21 (23)	26 (456)	120	-60 to 300 (-50 to 150)	Edge and hole reinforcing.
8412	Transparent	Acrylic	Polyester	4.7 (0.12)	6.3 (0.16)	33 (36)	140 (2450)	180	-60 to 300 (-50 to 150)	Heavy-duty edge and hole reinforcing.
Protective Tapes										
335	Pink	Rubber	Polyester	0.9 (0.02)	1.5 (0.04)	13 (0.5)	26 (455)	115	40 to 150 (4 to 65)	Low tack protective tape. Pink in color.
336	Transparent	Rubber	Polyester	0.9 (0.02)	1.5 (0.04)	13 (0.5)	26 (455)	115	40 to 150 (4 to 65)	Low tack protective tape. Transparent.
High Temperature Masking and Liner Splicing Tapes										
8401	Translucent Cream	Silicone/ Rubber Blend	Polyester	1.0 (0.03)	1.9 (0.05)	22 (24)	34 (595)	100	-60 to 300 (-50 to 150)	Splicing many release coated paper.
8402	Translucent Green	Silicone	Polyester	0.9 (0.02)	1.9 (0.05)	24 (26)	25 (438)	100	-60 to 425 (-50 to 218)	Adheres well to silicone.
8403/ 8403L	Translucent Green	Silicone	Polyester	1.4 (0.04)	2.4 (0.06)	27 (29)	46 (806)	150	-60 to 425 (-50 to 218)	Adheres well to silicone. 8403L is lined version.
8901	Blue	Silicone	Polyester	0.9 (0.02)	2.4 (0.06)	29 (31)	26 (455)	115	-60 to 400 (-50 to 204)	High temperature coating.
8902	Blue	Silicone	Polyester	2.0 (0.05)	3.5 (0.08)	37 (40)	46 (805)	100	-60 to 400 (-50 to 204)	High temperature coating.
8905	Blue	Silicone	Polyester	5.0 (0.12)	6.5 (0.17)	26 (28)	110 (1920)	115	-60 to 400 (-50 to 204)	High temperature coating.
8911	Transparent	Silicone	Polyester	0.9 (0.02)	2.3 (0.05)	26 (29)	26 (440)	110	-60 to 400 (-50 to 204)	High temperature label protection.
8991/ 8991L	Blue	Silicone	Polyester	1.0 (0.03)	2.4 (0.06)	31 (34)	21 (374)	49	-60 to 400 (-50 to 204)	Thin tapes, powder coat masking, high temperature applications. 8991L is lined version.
8992/ 8992L	Green	Silicone	Polyester	2.0 (0.05)	3.2 (0.08)	44 (48)	37 (642)	46	-60 to 400 (-50 to 204)	Powder coat and anodized masking, high temperature applications. 8992L is lined version.
Photo Film Splicing Tapes										
8421	White	Rubber	Polyester	1.4 (0.04)	2.5 (0.06)	50 (54)	43 (754)	140	-60 to 300 (-50 to 150)	Photo film splicing.
8422	Black	Rubber	Polyester	1.4 (0.04)	2.5 (0.06)	50 (54)	43 (754)	140	-60 to 300 (-50 to 150)	Photo film splicing.
8429	Yellow	Rubber	Polyester	2.0 (0.05)	3.2 (0.08)	69 (75)	54 (948)	130	-60 to 300 (-50 to 150)	Photo film splicing.
Reflective Tapes										
850	Silver	Acrylic	Polyester	0.9 (0.02)	1.9 (0.05)	42 (46)	28 (491)	120	-60 to 300 (-50 to 150)	Splicing, holding, sealing, decorating, silver color-coding.
8437	Silver	Acrylic	Polyester	0.9 (0.02)	2.1 (0.05)	40 (44)	20 (350)	70	40 to 200 (4 to 93)	Low emissivity.

Note: The technical information and data on these pages should be considered representative or typical only and should not be used for specification purposes.

3M™ PTFE and UHMW-PE Tapes

Low Coefficients of Friction With Choice of Other Characteristics

3M™ PTFE and UHMW-PE Tapes meet many application requirements for Printing, Aerospace, Automotive and MRO (Maintenance and Repair).

3M™ PTFE Tapes

- Low coefficient of friction to help improve web processing
- Resists up to 500°F (260°C) for long performance on heat sealing machines
- Anti-stick for easy cleanup of hot plastic
- Chemical-resistant barrier
- Silicone-free adhesive available

3M™ UHMW-PE Tapes

- Abrasion resistant to protect chutes, guide rails, and containers from wear
- Low coefficient of friction for “slip plane” effect between surfaces to reduce noise
- Anti-stick for ready release of many inks and adhesives



For automotive noise reduction, 3M™ UHMW-PE Tape 5425 provides a “slip plane” effect between incompatible surfaces to help reduce squeaks and rattles.

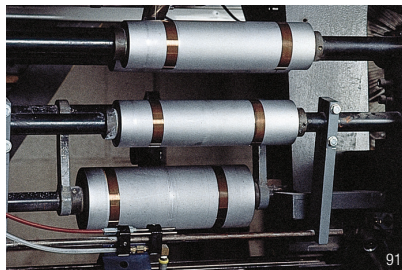

Conformable 3M™ PTFE Tape helps the movement of web materials in many types of roller wrapping applications.



Corrugated boxes slide more easily down a chute lined with abrasion-resistant 3M™ UHMW-PE Tapes.

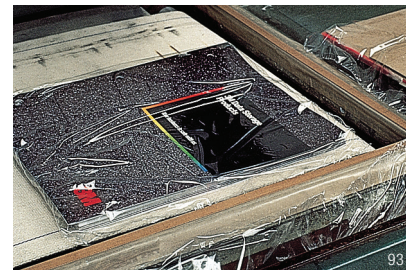

In shrink wrapping operation, 3M™ PTFE Glass Cloth Tape 5451 helps protect the bar underneath where the hot wire seals the plastic film.

3M™ Slick Surface Tapes — Performance Comparison

Attribute	Good	Better	Best
Heat Resistance	UHMW-PE Tape	PTFE Film Tape	PTFE Glass Cloth Tape
Wear Life	PTFE Film Tape	PTFE Glass Cloth Tape	UHMW-PE Tape
Conformability	PTFE Glass Cloth Tape	UHMW-PE Tape	PTFE Film Tape
Low Friction Coefficient	UHMW-PE Tape	PTFE Glass Cloth Tape	PTFE Film Tape
Anti-stick/Solvent Resistance	PTFE Glass Cloth Tape	UHMW-PE Tape	PTFE Film Tape

3M™ PTFE Tapes

Product	Color	Adhesive Type	Backing Material	Backing Thickness mils (mm)	Total Thickness mils (mm)	Adhesion to Steel oz/in (N/100 mm)	Tensile Strength lb/in (N/100 mm)	Elongation at Break %	Temperature Range °F (°C)	Comments
Based on ASTM Test Method:				D-3652	D-3652	D-3330	D-3759	D-3759		
Glass Cloth										
5151/ 5151L/ 5151PL	Light Brown	Silicone	PTFE GC	3.0 (0.08)	5.3 (0.13)	33 (36)	110 (1925)	5	-100 to 500 (-73 to 260)	General purpose PTFE glass cloth tape. 5151L is a lined version of 5151. 5151PL is a thicker, premium liner.
5153/ 5153L	Light Brown	Silicone	PTFE GC	5.8 (0.15)	8.0 (0.20)	43 (47)	290 (5075)	5	-100 to 500 (-73 to 260)	General purpose PTFE glass cloth tape. 5153L is a lined version of 5153.
5451	Brown	Silicone	PTFE GC	3.2 (0.08)	5.6 (0.14)	28 (31)	100 (1760)	5	-100 to 500 (-73 to 260)	Heat seal tape.
5453	Brown	Silicone	PTFE GC	6.0 (0.15)	8.2 (0.21)	55 (56)	175 (3065)	5	-100 to 500 (-73 to 260)	Heat seal tape.
Skived Film										
5180	Gray	Silicone	PTFE	2.0 (0.05)	3.5 (0.09)	25 (28)	30 (525)	100	-65 to 500 (-54 to 260)	General purpose PTFE skived film tape.
5181	Gray	Silicone	PTFE	5.0 (0.13)	6.5 (0.17)	35 (39)	75 (1300)	100	-65 to 500 (-54 to 260)	General purpose PTFE skived film tape.
5480	Gray	Silicone	PTFE	2.0 (0.05)	3.7 (0.09)	20 (22)	27 (473)	140	-65 to 500 (-54 to 260)	Roller wrapping tape.
5481	Gray	Silicone	PTFE	5.0 (0.13)	6.8 (0.17)	32 (35)	49 (858)	335	-65 to 500 (-54 to 260)	Heavy-duty roller wrapping tape.
Extruded Film										
5490	Gray	Silicone	PTFE	2.0 (0.05)	3.7 (0.09)	27 (29)	22 (385)	150	-65 to 500 (-54 to 260)	Lay-flat backing.
5491	Gray	Silicone	PTFE	5.0 (0.13)	6.7 (0.17)	35 (38)	40 (700)	200	-65 to 500 (-54 to 260)	Lay-flat backing.
5498	Brown	Rubber	PTFE	2.0 (0.05)	4.0 (0.10)	48 (53)	19 (332)	105	40 to 300 (4 to 149)	Non-silicone adhesive.

3M™ UHMW-PE Tapes

Product	Color	Adhesive Type	Backing Material	Backing Thickness mils (mm)	Liner Type	Total Thickness mils (mm)	Adhesion to Steel oz/in (N/100 mm)	Tensile Strength lb/in (N/100 mm)	Elongation at Break %	Temperature Range °F (°C)	Comments
Based on ASTM Test Method:				D-3652		D-3652	D-3330	D-3759	D-3759		
5421	Transparent	Rubber	UHMW-PE	5.0 (0.13)	60# Densified Kraft Paper	6.7 (0.17)	26 (28)	30 (526)	275	-30 to 225 (-34 to 107)	General purpose tape to protect plastic and metal chutes, guide rails and containers from wear.
5423	Transparent	Rubber	UHMW-PE	10.0 (0.25)	60# Densified Kraft Paper	11.7 (0.30)	26 (28)	55 (963)	300	-30 to 225 (-34 to 107)	Excellent abrasion resistance and low coefficient of friction makes this an effective solution for noise and vibration problems.
5425	Transparent	Acrylic	UHMW-PE	3.0 (0.08)	55# Densified Kraft Paper	5.0 (0.13)	30 (33)	45 (788)	100	-30 to 225 (-34 to 107)	Solvent resistant adhesive with low coefficient of friction and abrasion resistance.
5430	Transparent	Acrylic	UHMW-PE	5.0 (0.13)	55# Densified Kraft Paper	7.0 (0.18)	75 (82)	40 (696)	175	-30 to 225 (-34 to 107)	High tack adhesive.
9324	Black	Acrylic	UHMW-PE	5.0 (0.13)	55# Densified Kraft Paper	6.5 (0.17)	75 (82)	40 (696)	175	-30 to 225 (-34 to 107)	Black version of 5430 tape.
9325	Transparent	Acrylic	UHMW-PE	3.0 (0.08)	55# Densified Kraft Paper	5.0 (0.13)	50 (55)	40 (696)	175	-30 to 225 (-34 to 107)	Thin version of 5430 tape.

Note: The technical information and data on these pages should be considered representative or typical only and should not be used for specification purposes.

3M™ Vinyl and Polyethylene Tapes

Mark, Identify, Color-Code, Seal Seams and More

These rugged tapes adhere aggressively and remove cleanly from most surfaces for a wide variety of applications in Automotive, MRO (Maintenance and Repair), Construction, Marine, Commercial Vehicle, and other industries.

Applications include marking hazards and aisles, color coding of pipes, fine line paint masking, decorative trim, high visibility splicing and more.

- “Color throughout” construction resists scrapes, wear, weathering and chemicals
- Wide variety of colors plus transparent
- Flexible backing with aggressive adhesive bonds, conforms and seals even on irregular surfaces
- Removes cleanly without leaving adhesive behind to clean up
- Stretches to mold to contours

See our lane marking applicators on page 45.



3M™ Vinyl Tapes clearly mark lanes, corridors and hazardous or no-go areas in factories, warehouses and hospitals. Durable vinyl backing resists abrasion, scuffing, moisture, weathering, acids and alkaline chemicals for long service life.



Red 3M™ Vinyl Tape immediately identifies fire protection equipment and apparatus, including fire extinguishers, alarm boxes and blanket boxes.



For color-coding pipes with 3M™ Vinyl Tapes, select from either nine vivid colors or transparent to let underlying color show through. Backing is colored throughout to help maintain ready visibility.



For fine line paint masking, 3M™ Vinyl Tape 471 provides sharp paint lines and the clean removal of a firm rubber adhesive.



To highlight low hanging objects, protruding equipment, or steps, 3M™ Vinyl Tape 5702 combines yellow and black for a striped combination that calls for attention.

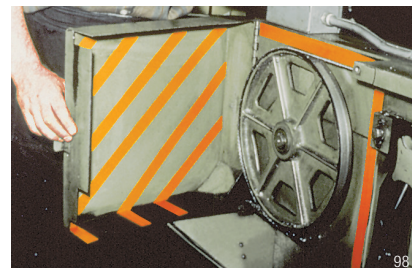

Orange 3M™ Vinyl Tape identifies dangerous machine parts that may cause injury when enclosure doors are open or guards removed.

3M™ Vinyl Tapes

Product Number	Color	Adhesive Type	Backing Material	Backing Thickness mils (mm)	Total Thickness mils (mm)	Adhesion to Steel oz./in. (N/100 mm)	Tensile Strength lb./in. (N/100 mm)	Elongation at Break %	Temperature Range °F (°C)	Comments
Premium Performance Vinyl Tapes										
471	Various	Rubber	Vinyl	4.1 (0.10)	5.2 (0.13)	26 (28)	14 (270)	150	40 to 170 (4 to 77)	Conformable and clean removal. Black, Blue, Brown, Green, Orange, Purple, Red, Transparent, White, Yellow. MIL-STD 2041D (SH).
4712	Various	Rubber	Vinyl	4.1 (0.10)	5.2 (0.13)	23 (25)	14 (270)	150	40 to 170 (4 to 77)	Lined version of 471 tape. MIL-STD 2041D (SH). Colors same as 471.
471+	Indigo	Rubber	Vinyl	4.1 (0.10)	5.3 (0.13)	35 (38.3)	13.9 (243)	191	Up to 250 (Up to 121)	Superior conformability, sharp paint lines, clean removal.
472	Black	Rubber	Vinyl	9.0 (0.23)	10.4 (0.26)	23 (25)	32 (560)	270	Up to 225 (Up to 107)	Abrasion and high temperature resistant.
477	Transparent	Rubber	Vinyl	6.0 (0.15)	7.2 (0.18)	24 (26)	24 (420)	230	40 to 170 (4 to 77)	Abrasion resistant.
General Purpose Vinyl Tapes										
764	Various	Rubber	Vinyl	4.1 (0.10)	5.0 (0.13)	18 (21)	13 (228)	180	60 to 85 (15 to 27)	Non-critical applications. Black, Blue, Brown, Gray, Green, Orange, Purple, Red, Transparent, White, Yellow.
Safety Stripe Tapes										
5700	Black/White	Rubber	Vinyl	4.2 (0.11)	5.5 (0.14)	19 (21)	15 (260)	170	40 to 170 (4 to 77)	Critical applications. Adhesive side printing for long-life.
5702	Black/Yellow	Rubber	Vinyl	4.2 (0.11)	5.5 (0.14)	19 (21)	15 (260)	170	40 to 170 (4 to 77)	Critical applications. Adhesive side printing for long-life.
766	Black/Yellow	Rubber	Vinyl	4.1 (0.10)	5.0 (0.13)	18 (21)	13 (228)	180	60 to 85 (15 to 27)	Non-critical marking applications.
767	Red/White	Rubber	Vinyl	4.1 (0.10)	5.0 (0.13)	18 (21)	13 (228)	180	60 to 85 (15 to 27)	Non-critical marking applications.
Electroplating and Anodizing Tapes										
470	Tan	Rubber	Vinyl	6.3 (0.16)	7.1 (0.18)	37 (40)	20 (350)	180	Up to 170 (Up to 77)	Conformable and abrasion resistant for masking various surfaces during electroplating and anodizing.
484	Tan	Rubber	Vinyl	5.6 (0.14)	6.7 (0.17)	22 (24)	23 (402)	220	Up to 170 (Up to 77)	Lower adhesion than 470 tape.
4731	Various	Rubber	Vinyl	5.8 (0.15)	7.0 (0.18)	20 (22)	17 (300)	230	40 to 170 (4 to 77)	Electroplating. Blue, Gray, Orange, Purple, White, Yellow.

3M™ Polyethylene Tapes

Product Number	Color	Adhesive Type	Backing Material	Backing Thickness mils (mm)	Total Thickness mils (mm)	Adhesion to Steel oz./in. (N/100 mm)	Tensile Strength lb./in. (N/100 mm)	Elongation at Break %	Temperature Range °F (°C)	Comments
Polyethylene Tapes										
480	Transparent	Acrylic	Polyethylene	4.0 (0.10)	5.1 (0.13)	22 (24)	12 (210)	520	20 to 170 (-7 to 76)	Acrylic adhesive.
483	Various	Rubber	Polyethylene	3.9 (0.10)	5.0 (0.13)	18 (21)	10 (175)	300	Up to 170 (Up to 77)	Available in Black, Blue, Green, Red, Transparent, White and Yellow. MIL-STD 2041D (SH).

Note: The technical information and data on these pages should be considered representative or typical only and should not be used for specification purposes.

3M™ Gripping Materials

Increase Friction and Reduce Slippage in Dry, Wet and Oily Conditions

When getting a grip is a performance requirement, strengthen your competitive advantage with 3M™ Gripping Material products. This 3M innovation utilizes 3M patented micro-replication technology to add thousands of micro gripping fingers on one side of a flexible backing to enhance control and improve gripping performance. Customers will see a noticeable increase in holding power, while using less force, no matter what the end use application. Ultimately this can lead to enhanced performance and decreased fatigue.

Adhesives-backed versions stick on contact to many metals, plastics and sealed woods for a fast, easy increase in traction for applications such as fishing rods, ATV handlebars and forklift steering wheels.

Plain-backed versions offer some stretch and are designed for sew-on applications such as sports gloves or work gloves, where improved grip is a performance advantage.

Molded grips can be custom designed and manufactured for different high volume applications.

Performance Features:

- Increases friction to reduce slippage even in wet or oily conditions
- Immediate release when the hand lets go
- Abrasion and puncture resistant
- Water and oil resistance for secure attachment
- Performs across a broad temperature range from -40 to 160°F (-40 to 71°C) indoors and out



The unique micro-replicated surface structure of 3M™ Gripping Materials is engineered to provide different levels of friction, and when mated, create unmatched holding power, even in wet and oily environments.

Product	Color	Durability 1-10: Low-High	Friction 1-10: Low-High		Tactility 1-10: Soft-Firm	Thickness mil (mm) without liner	Weight oz/yd ² (g/m ²) without liner	Temperature Use Range °F (°C)	Chemical Resistance	UV Resistance	Size
			Mated	Unmated							
Plain-backed: Washable nylon knit with moderate stretch for sew-on applications											
GM110	Black	10	10	3	10	33 (0.8)	10.7 (366)	-40 to 160 (-40 to 71)	10	10	24" x 72 yd
GM530	Black	9	10	5	8	33 (0.8)	10.7 (366)	-40 to 160 (-40 to 71)	8	8	24" x 72 yd
GM613	Grey	1	7	10	1	33 (0.8)	10.7 (366)	-40 to 160 (-40 to 71)	3	5	24" x 72 yd
GM630	Grey	5	8	9	4	33 (0.8)	10.7 (366)	-40 to 160 (-40 to 71)	5	5	24" x 72 yd
GM640	Black	8	9	7	6	33 (0.8)	10.7 (366)	-40 to 160 (-40 to 71)	7	5	24" x 72 yd
Adhesive-backed: 3M pressure sensitive acrylic for bonding to high and low surface energy materials											
GM400	Black	10	10	3	10	33 (0.8)	12.9 (440)	-40 to 160 (-40 to 71)	10	10	1" x 72 yd or 24" x 72 yd
GM531	Black	9	10	5	8	33 (0.8)	12.9 (440)	-40 to 160 (-40 to 71)	8	8	1" x 72 yd or 24" x 72 yd
GM614	Grey	1	7	10	1	33 (0.8)	12.9 (440)	-40 to 160 (-40 to 71)	3	5	1" x 72 yd or 24" x 72 yd
GM631	Grey	5	8	9	4	33 (0.8)	12.9 (440)	-40 to 160 (-40 to 71)	5	5	1" x 72 yd or 24" x 72 yd
GM641	Black	8	9	7	6	33 (0.8)	12.9 (440)	-40 to 160 (-40 to 71)	7	5	1" x 72 yd or 24" x 72 yd
GM731	Clear	10	10	3	10	33 (0.8)	12.9 (440)	-40 to 160 (-40 to 71)	10	7	1" x 72 yd or 24" x 72 yd

Note: The technical information and data on these pages should be considered representative or typical only and should not be used for specification purposes.

Splicing and Repulpable Tapes

When You Need to Splice it Up

We offer a wide range of repulpable and non-repulpable tapes for every kind of splice so you can continue your production pace at full speed. Our products are designed to provide dependable splices. From temporary to permanent adhesion needs, our tape experts can help you select the best tape for your demanding application.

3M™ Splicing and Repulpable Tapes

Tapes for Paper Mills, Printers, Converters and Newspapers

From core starting to roll closing/tabling and all the splices in-between, this totally repulpable line offers choices for the dependability you need to keep production at full speed. Backings and adhesives are engineered for optimum strength on every type of splice: flying, overlap, butt and general purpose.

Temporary Tapes

Good shear strength, high tack and reliable heat resistance

Permanent Tapes

High shear strength to stay with paper through sheeting, printing, slitting and perforating



3M™ Repulpable Splittable Flying Splice Tape eliminates the time and work of “V” and “W” patterns with a straight across flying splice. Advanced coating provides a smooth and consistent opening force. A fiber-free break open means less blanket cleanup.



High tack 3M™ Temporary Single Coated Repulpable Tapes are available in white, blue, and kraft for dependable core starting, roll closing and butt splicing.



3M provides a complete line of core starting tapes that are easy to use and stick reliably every time.



For finished mill overlap splicing, 3M™ Repulpable Permanent Tape provides high shear strength without adhesive oozing or bleed through.

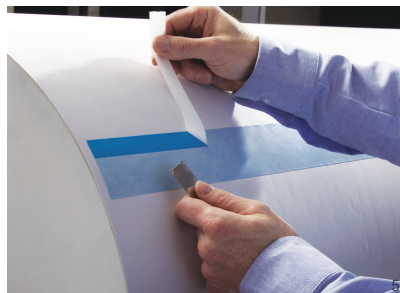

One simple splice with 3M™ Splittable Flying Splice Tape replaces complex patterns.



For “V” and “W” pattern splices, the 3M™ Splicing System provides all the splicing products you need.

3M™ Repulpable Splicing Tapes for the Paper Mills

Product	Color	Comments	Tape Thickness mils (mm)	Tape Structure		Liner		Heat Resistance °F (°C)	FDA Compliant†
				Backing/Carrier	Adhesive	Type	Thickness mils (mm)		
Permanent Double Coated									
405	Lt. Green	Excellent for raw and starch-treated papers	3.0 (0.08)	Tissue Carrier	Repulpable	UPVC	1.7 (0.04)	400 (200)	—
900	Blue	Recommended for light weight coated papers	2.5 (0.06)	Tissue Carrier	Repulpable	Paper	3.2 (0.08)	400 (200)	Yes
900B	Blue	Recommended for supercalendered papers	2.5 (0.06)	Tissue Carrier	Repulpable	Paper	3.2 (0.08)	400 (200)	Yes
Permanent Single Coated									
901	Lt. Green	Excellent for raw and starch-treated papers	4.0 (0.10)	Paper	Repulpable	UPVC	1.7 (0.04)	400 (200)	—
910	Blue	Recommended for coated and uncoated papers and paperboard	4.0 (0.10)	Paper	Repulpable	—	none	400 (200)	Yes
914	Blue	Recommended for high speeds, digital business forms, perforated splicing tape	4.0 (0.10)	Paper	Repulpable	—	none	400 (200)	Yes
9103	Blue	Printable, coatable backing	4.5 (0.11)	Paper	Repulpable	Paper	2.9 (0.07)	400 (200)	Yes
9114	Blue	The easiest way to make a butt splice; Printable	4.5 (0.11)	Paper	Repulpable	Paper	2.9 (0.07)	400 (200)	Yes
9960	Blue	Thinnest butt splicing tape for light weight uncoated and coated and supercalendered papers	2.2 (0.06)	Paper	Repulpable	Paper	2.9 (0.07)	350 (180)	Yes
9969	Blue/White	Very thin butt splicing/cover tape for uncoated, newsprint and most coated papers	2.2 (0.06)	Paper	Repulpable	Paper	2.9 (0.07)	350 (180)	Yes
Adhesive Transfer Tape									
R3037	Blue	Thinnest, fiber reinforced adhesive transfer tape	2.0 (0.05)	None	Repulpable	Paper	3.3 (0.08)	250 (120)	Yes
Temporary Double Coated									
906	Blue/White	Flying splice at the Off-Machine Coater (OMC)	3.0 (0.08)	Tissue Carrier	Repulpable	Paper	3.2 (0.08)	400 (200)	Yes
9069	Blue	Excellent for newsprint or directory stock	3.5 (0.09)	Tissue Carrier	Repulpable	Paper	3.2 (0.08)	400 (200)	—
9977	Blue	High strength tissue for flying splices where extra strength is needed	4.0 (0.10)	Tissue Carrier	Repulpable	Paper	3.2 (0.08)	400 (200)	—
R3227	Blue/White	General purpose temporary splicing	3.5 (0.09)	Tissue Carrier	Repulpable	Paper	3.2 (0.08)	400 (200)	Yes
R3257	White	Thin tissue, very high tack	4.1 (0.11)	Tissue Carrier	Repulpable	Paper	3.2 (0.08)	400 (200)	Yes
R3287	White	Heavy tissue, very high tack	5.5 (0.14)	Tissue Carrier	Repulpable	Paper	3.2 (0.08)	400 (200)	Yes
Temporary Single Coated									
R3127	Blue/White/Kraft	General purpose, excellent holding power	4.5 (0.11)	Paper	Repulpable	—	none	400 (200)	Yes
R3177	Blue/White/Red	Heavy duty, extensible repulpable backing	7.0 (0.16)	Paper	Repulpable	—	none	400 (200)	Yes
R3187	Blue/White/Kraft	General purpose, strong repulpable backing	7.5 (0.19)	Paper	Repulpable	—	none	400 (200)	Yes
Splittable Flying Splice (SFS)									
R3345	Blue	Thin SFS tape for flying splices through supercalendering operations, and permanent butt splices for light weight coated papers	4.8 (0.12)	Paper	Repulpable	Paper	2.9 (0.07)	400 (200)	—
R3375	Blue	Strong SFS tape for flying splices on heavy papers and high tension web processing through supercalendering operations	6.5 (0.16)	Paper	Repulpable	Paper	2.9 (0.07)	400 (200)	—
R3379	Blue	Repulpable Splittable Flying Splice Tape is used for high speed splicing conditions when high tack is required and to compensate for roll profile issues	7.5 (0.18)	Paper	Repulpable	Paper	2.9 (0.07)	400 (200)	—
R9996	Blue	Thinnest SFS tape for splicing applications in paper mills and paper converting coating operations	4.8 (0.12)	Paper	Repulpable	Paper	2.9 (0.07)	400 (200)	—
R9999	Blue	Repulpable Splittable Flying Splice Tape for heavyweight papers in manual and automatic splicing equipment, with moderate speed	6.7 (0.17)	Paper	Repulpable	Paper	2.9 (0.07)	400 (200)	—

†All components of the adhesive and backing meet the requirements of indirect food additive regulations as described under 21 CFR 176.170 (Components of paper and paperboard in contact with aqueous and fatty food) and 21 CFR 176.180 (Components of paper and paperboard in contact with dry foods).

Note: The technical information and data on these pages should be considered representative or typical only and should not be used for specification purposes.

3M™ Splicing Tapes for the Printing Industry

Product	Color	Comments	Tape Thickness mils (mm) without liner	Tape Structure		Liner		Heat Resistance* °F (°C)	FDA Compliant†
				Backing/ Carrier	Adhesive	Type	Thickness mils (mm)		
Repulable Adhesive Transfer Tape									
R3037	Blue	Thinnest, fiber reinforced adhesive transfer tape	2.0 (0.05)	None	Repulable	Paper	3.3 (0.08)	250 (120)	Yes
Repulable Single Coated									
R3127	Blue/ White/Kraft	General purpose, excellent holding power	4.5 (0.11)	Paper	Repulable	—	none	400 (200)	Yes
R3187	White/Kraft	General purpose, strong repulable backing	7.5 (0.19)	Paper	Repulable	—	none	400 (200)	Yes
R3177	Blue/ White/Red	Heavy duty, extensible repulable backing	7.0 (0.16)	Paper	Repulable	—	none	400 (200)	Yes
Repulable Double Coated									
913	Blue	Paster tape for splices at newspaper printers	3.5 (0.09)	Tissue Carrier	Repulable	Paper	3.2 (0.08)	400 (200)	—
9038	Blue/White	General purpose plus flying splice tape for commercial printers and corrugators	3.5 (0.09)	Tissue Carrier	Repulable	Paper	3.2 (0.08)	350 (180)	Yes
9069	Blue	Excellent for newsprint or directory stock	3.5 (0.09)	Tissue Carrier	Repulable	Paper	3.2 (0.08)	400 (200)	—
R3227	Blue/White	For zero speed splicing	3.5 (0.09)	Tissue Carrier	Repulable	Paper	3.2 (0.08)	400 (200)	Yes
Splittable Flying Splice (SFS)									
R5348	Blue	Use with light- to medium-weight papers running through medium-temperature ovens	5.0 (0.11)	Paper	Repulable	Paper	2.9 (0.07)	350 (180)	—
R7359	Blue	Use with light- to heavy-weight papers running at high speeds and high temperatures	6.6 (0.17)	Paper	Repulable	Paper	2.9 (0.07)	400 (200)	—
R7369	Blue	Use with light- to heavy-weight paper on wide web rolls to help compensate for roll profile variations running at high speeds and high temperatures	7.4 (0.19)	Paper	Repulable	Paper	2.9 (0.07)	400 (200)	—
9990N	Blue	Splittable flying splice (SFS) system with metalized layer for auto-sensing splice detection applications	5.5 (0.14)	Aluminized Paper**	Repulable	Paper	2.2 (.05)	350 (180)	—
R9993	Blue	All in one tabbing and splicing tape for heatset printing applications	5.0 (0.11)	Paper	Repulable	Paper	2.9 (0.07)	400 (200)	—

*As tested in laboratory. Results may vary depending on machine and web tensions, nature of paper surface, application pressure, etc. which are outside of 3M's control.

**Non-repulable, screenable aluminized sensor strip.

†All components of the adhesive and backing meet the requirements of indirect food additive regulations as described under 21 CFR 176.170 (Components of paper and paperboard in contact with aqueous and fatty food) and 21 CFR 176.180 (Components of paper and paperboard in contact with dry foods).

3M™ Non-Repulable Splicing Tapes (All tapes in this chart can be considered for zero speed or flying splices)

Product	Product Description	Tape Thickness mils (mm) without liner	Carrier		Color	Adhesion oz/in (N/25 mm)	Heat Resistance* (Short-term) °F (°C)	Go-To Application	
			Thickness mils (mm)	Type				Zero Speed	Flying Splice
Based on ASTM Test Method			D-3652	D-3652		D-3330			
Adhesive Transfer Tape									
465	High tack, excellent adhesion to most paper stocks, flexible to -60°F	2.0 (0.05)	—	none	Clear	25 (6.8)	250 (121)		
9498/9464	Low temperature splicing	2.0 (0.05)	—	none	Clear/Red	20 (6.0)	250 (121)	■	
9499/9497	High temperature splicing	2.0 (0.05)	—	none	Clear/Red	45 (12.5)	350 (177)	■	
Double Coated Tapes									
415/9420	High tack adhesion to paper and many other surfaces	4.0 (0.10)	0.5 (0.01)	Polyester	Clear/Red	25 (6.8)	180 (82)		
469	High temperature, high tack	5.5 (0.14)	1.0 (0.02)	Tissue	Red	60 (16.7)	350 (177)		■
9086	Easy tearing, easy handling, thick high tack adhesive, very conformable	7.5 (0.19)	1.5 (0.03)	Non-Woven Tissue	Clear	146 (40.0)	250 (121)		
9088	High temperature resistance, high tack and shear strength	8.3 (0.20)	0.5 (0.01)	Polyester	Clear	137 (37.5)	300 (150)		
9576	Medium tack for general splicing and roll closing	4.0 (0.10)	1.0 (0.02)	Polypropylene	Red/Black/ Yellow	30 (13.5)	165 (75)		
9737/9737R	Thin PET carrier, aggressive and versatile tape for many surfaces	3.5 (0.09)	0.5 (0.01)	Polyester	Clear/Red	60 (16.7)	300 (150)	■	■
9738/9738R	Non-woven tissue carrier, aggressive and versatile tape for many surfaces	4.3 (0.11)	1.3 (0.03)	Non-Woven Tissue	Clear/Red	60 (16.7)	300 (150)	■	■
9740	High performance over a wide range of temperatures, high peel, tack, and shear properties, performance grade splicing for corrugators	3.5 (0.09)	0.5 (0.01)	Polyester	Clear	70 (21.2)	425 (218)		■
9741/9741R	Thick tape adheres to a wide variety of substrates, super aggressive for low surface energy substrates	6.5 (0.17)	0.5 (0.01)	Polyester	Clear/Red	120 (34.0)	200 (93)		

*As tested in laboratory. Results may vary depending on machine and web tensions, nature of paper surface, application pressure, etc. which are outside of 3M's control.

Note: The technical information and data on these pages should be considered representative or typical only and should not be used for specification purposes.

3M™ Splicing Tapes Selection Guide

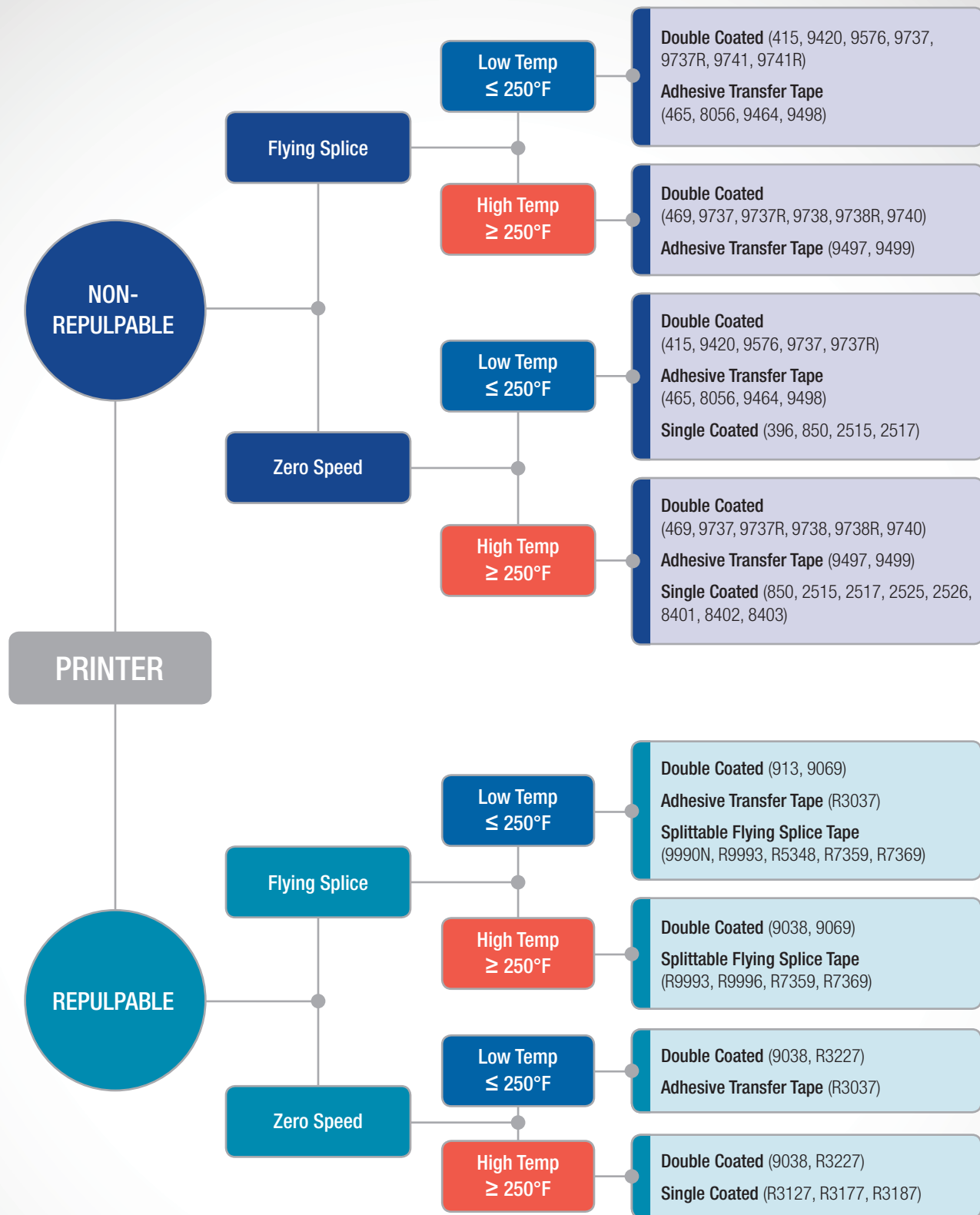

Temperature ratings are dependent on oven time, web tension, web speed and substrate thickness. See data page for exact temperature rating.



Equipment

Easy to Use

Fast and Effective

From hand-held to walk-behind, or custom-mounted to portable, our applicators and dispensers are specially designed for use with 3M Masking and Surface Protection Products.

3M™ Lane Marking Applicators



3M™ Lane Marking Applicator M1



Product	Product Name	Product Description	Color
M1	3M™ Lane Marking Applicator M1	Lane Marking Applicator M1 is used to apply vinyl tape to floor surfaces in manufacturing and commercial plants. General use.	Red
M77	3M™ Lane Marking Applicator M77	Lane Marking Applicator M77 is used to apply vinyl tape to floor surfaces in manufacturing and commercial facilities. Heavy duty.	Red

3M™ Tape Dispensers

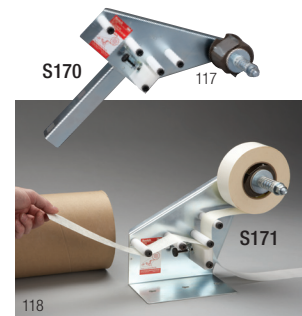
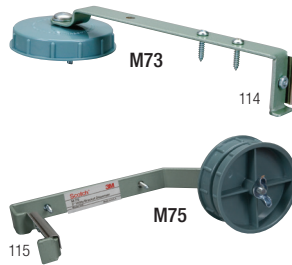

3M™ Dispenser for Flashing Tape H330
 3M™ Dispenser for Flame Retardant Tape H331
 3M™ Utility Bracket Dispensers
 3M™ Repulpable Tape Applicator
 3M™ Set Change Dispensing Systems

Product	Product Name	Product Description	Color
H330	3M™ Dispenser for Flashing Tape H330	A hand-held dispenser that provides a quick and easy method to apply 3M™ All Weather Flashing Tape 8067 and 3M™ Sealing Tape 8777. Accommodates up to a 6 inch wide tape on a 3 inch core.	Red
H331	3M™ Dispenser for Flame Retardant Tape H331	A hand-held dispenser that provides a quick, easy and inexpensive method to apply 3M™ Glass Cloth Tape 398FR and 3M™ Flame Retardant Glass Cloth Tape 399FR. Accommodates up to a 6 inch wide tape on a 3 inch core.	Gray
M73	3M™ Utility Bracket Dispenser M73	Utility bracket dispensers can be custom-mounted on walls, equipment, tables, and to the sides of work stations. This model holds 1/4 inch to 1 inch wide.	Blue
M75	3M™ Utility Bracket Dispenser M75	Utility bracket dispensers can be custom-mounted on walls, equipment, tables, and to the sides of work stations. This model holds 1/4 inch to 2 inches wide.	Blue
RTA500	3M™ Repulpable Tape Applicator RTA500	A hand-held tape dispenser designed to dispense 3M lined repulpable tapes, while simultaneously removing the liner.	Tan
S170	3M™ Set Change Dispensing System S170	Use for dispensing repulpable core starting tape while removing liner. Accommodates up to 2 inch wide tape.	Silver
S171	3M™ Set Change Dispensing System S171	Table top version. Use for dispensing repulpable core starting tape while removing liner. Accommodates tape up to 2 inches wide.	Silver

See our vinyl tapes on page 37.

3M™ Dispensers for Large Area Masking



Product	Product Name	Product Description
06781	Scotch® Cart Masker 06781	Portable masker provides a convenient method to adhere masking tape to the edge of masking paper for paint masking. Features two paper dispensing stations. Up to 24" wide paper.
06780	3M™ Overspray Protective Sheet Masker 06780	Portable masker designed to dispense sheeting. Allows for easy hand cutting of plastic sheeting.
06864	Scotch® Slimline Apron Taper 06864	Dispenses three widths of masking paper up to 18" wide. Side hooks hold different tape widths for special needs.
06865	Scotch® Apron Taper 18" 06865	Provides a convenient method for adhering masking tape to the edge of masking paper for paint masking.
06866	Scotch® Apron Taper 36" 06866	Features top loading, and easy operation and adjustment.

3M Tape Dispenser Replacement Parts

Dispenser Parts
 241 Venture Drive
 Amery, WI 54001
 Phone: 1-800-344-9883
 Fax: 715-268-8153

Replacement Blades

Atscott Manufacturing
 Company, Inc.
 1150 Holstein Drive N.E.
 Pine City, MN 55063
 Phone: 320-629-2501, ext. 116
www.atscott.com

Technical Appendix for Protective Tapes

3M™ Protective Tapes

The 3M™ Protective Tape Products Selection Guide is a quick reference of standard 3M™ Protective Tape Products to help the user select appropriate tapes for consideration and evaluation in their applications. Products are color-coded by product family for easy reference.

Please remember that many factors can affect the use and performance of a 3M™ Protective Tape Product in a particular application:

- Surface texture of substrate
- Surface preparation of substrate (including use of solvents)
- Method and conditions of tape application
- Time and environmental conditions
- Storage conditions

It is essential that the user evaluate the 3M™ Protective Tape Product to determine whether it is suitable for a particular purpose to meet the user's expectation.

Protective Tape Product Families

Polyethylene Tapes

- Better transparency
- Good abrasion resistance
- Cost effective

UV Tapes — Clear and Blue

- Outdoor UV resistance for up to 5 months
- Available in transparent and blue

UV Tapes — Co-Extruded Black/White

- Enhanced outdoor UV resistance for up to 9 months

Carpet Tapes

- Good transparency
- Easy unwind

Fire Retardant Tapes

- Complies with many fire-retardant tests
- Stays in place during use
- Removes cleanly

Co-Extruded “A” Tapes

The best choice in a 3M™ Protective Tape

- Excellent conformability
- Enhanced abrasion and puncture resistance
- Good heat resistance

Polypropylene Tapes

- Good abrasion resistance
- Good heat resistance
- Good short-term outdoor UV resistance

Polyester Tapes

- Best optical clarity
- Excellent heat resistance
- Excellent puncture resistance

Self Sealing Films

- Clear film that seals to itself
- Ideal for packaging small parts
- Tamper-proof packaging

3M Temporary Surface Protection Tape Product Identification

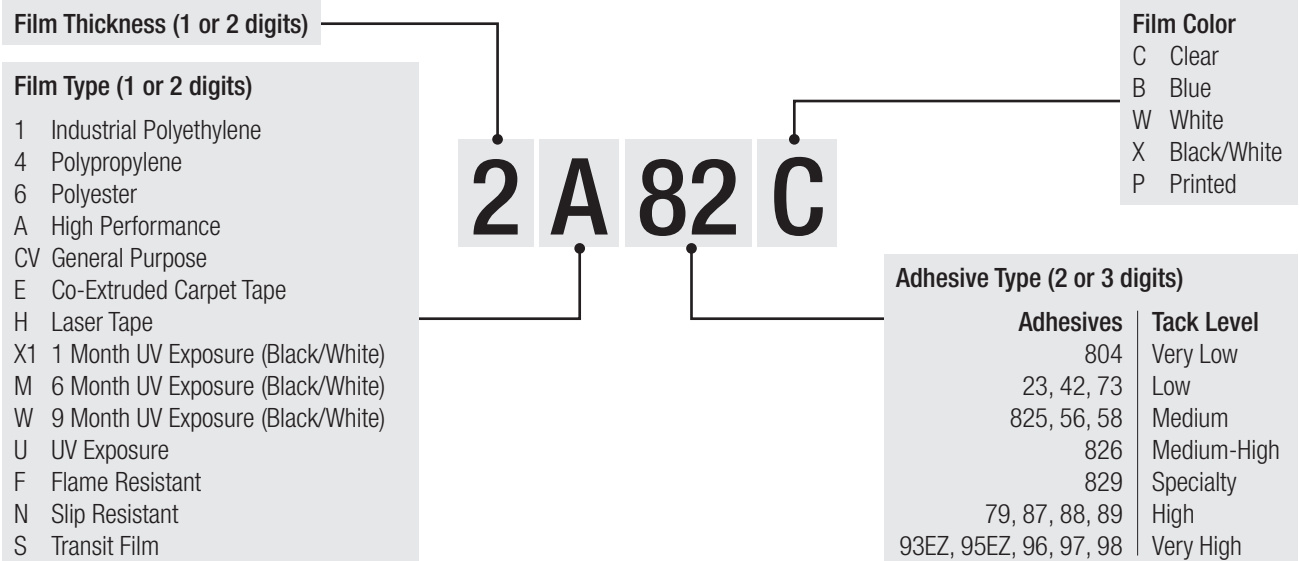

Glossary

This glossary is compiled by the Pressure Sensitive Tape Council (PSTC) and 3M (terms identified with an asterisk). PSTC is the North American trade association for tape manufacturers and affiliate suppliers, dedicated to helping the industry produce quality pressure sensitive adhesive tape products in the global marketplace. Visit www.pstc.org for more information.

Abrasion Resistance

The ability of a tape to withstand rubbing and still function satisfactorily.

Accelerated Aging

A means whereby the deterioration of a tape encountered in natural aging may be accelerated and reproduced in the laboratory.

Accelerated Weathering (Weathering)

Exposure in a chamber to ultraviolet light, heat, and water whereby the effect of outdoor exposure on a tape can be approximated.

Acrylic Adhesive*

A pressure sensitive, viscoelastic blend of acrylic-based materials which may be modified by tackifying additives. Acrylic adhesives are a very broad class of materials and come in many types to achieve different properties.

Adhesion to Backing

The bond produced to the backing of the same tape or another tape backing.

Adhesive Deposit or Residue

Adhesive that is pulled away from the tape upon removal and remains on the surface to which it has been applied.

Adhesive Transfer

When the adhesive on a tape either splits or transfers completely from the backing on to the surface it has been applied to either during unwind or removal, resulting in tacky areas on the surface.

Anchorage

The specific adhesion of a pressure sensitive adhesive to a face material or an anchor coat.

AOC*

Aircraft On Ground

Article Letters

Letters if a MSDS does not exist on a product.

Backing

A relatively thin flexible material to which the adhesive is applied. Theoretically, any material that is reasonably flat, thin and flexible can be used as a tape backing.

Backsize

An occlusive coating applied to the non-pressure sensitive side of a porous backing, such as paper, in order to provide a satisfactory surface that the pressure sensitive adhesive side can contact when the tape is wound into a roll.

Bleed-through (Bleeding)

Penetration through the tape of a coloring material (paint, etc.) onto the surface to which the tape is applied.

Blocking

Adhesion between the sheets of the plies of rolls of coated material, usually due to extreme conditions of pressure, temperature or humidity.

BSR*

An acronym for Buzz, Squeak and Rattle.

Bursting Strength

The ability of a tape to resist damage when a force is applied evenly and perpendicularly to the surface of a tape.

Butt Splice (Butt Joint)*

Splices made on certain converting equipment (especially in heavy basis weight paper, boards, etc.). The trimmed ends of the web do not overlap but are held together end-to-end with single-sided adhesive tape, or in some similar fashion. A strip of paper or tape may also be laminated on one or both sides to form a continuous web.

Caliper

The thickness (as of a sheet of paper) measured under specified conditions. See also THICKNESS.

Carrier

A webstock that holds a pressure sensitive adhesive, especially used to refer to double-faced or double coated tapes.

CID*

In relation to military specs = Commercial Item Description.

Clean Removal*

When a tape is expected to remove cleanly from the substrate after a period of time.

Coating Weight

The weight of a coating per unit area. In SI-units expressed as grams per square meter (g/m²).

Co-extruded*

Refers to film extruded in individual layers with the possibility of different raw materials in each layer providing unique combined film properties.

Cohesion (Cohesive Strength, Internal Bond)

The ability of the adhesive to resist shear stress and splitting. Good cohesion is necessary for clean removal.

Cold Flow

The tendency of a pressure sensitive adhesive to act as a heavy viscous liquid over long periods of time. Such phenomena as oozing and increase in adhesion with time are the result of this characteristic.

Color Stability

The ability of a tape to retain its original color, particularly when exposed to light.

Conformability*

The ability for a tape to make arcs, circles, go into depressions, go over protrusions and still stay in one piece without slivering, tape lifting, necking down.

*Compiled by 3M.

Glossary (cont.)

Controlled Unwind*

When a balance is achieved between too low of an unwind, allowing the tape to prematurely unwind from its own backing, or too high, causing premature slivering or breaking when unwinding from its roll.

Corona Resistance

The ability of an elastomeric adhesive, coating, or sealer acting as an insulator to withstand the effects of high voltage discharge. Indications of failure appear as surface cracks.

Cratering*

A paint defect that when viewed under a microscope resembles a crater with a depression in the center and a raised rim around the perimeter. This usually is caused by a surface contaminant like a particle of dirt, gel particle or a surface tension change like from an oil drop or silicone contamination.

Creep

The slow movement of the adhesive or backing under shear stress.

Crepe Paper*

Paper with a crinkled or puckered texture. This allows the paper to stretch or elongate making it useful to curve and conform to irregular surfaces better than flat paper.

Cross-linking

Developing a three-dimensional molecular structure in an adhesive normally activated by heat or irradiation. An improvement in shear resistance, high temperature resistance, and oil or solvent resistance will normally result.

Cure

To alter the properties of an adhesive by chemical reaction, which may be condensation, polymerization, or vulcanization. Usually accomplished by the action of heat and catalysts, alone or in combination, with or without pressure.

Curl

The tendency of paper by itself or in a laminate to bend or partly wrap around the axis of one of its dimensions.

Dead Soft Aluminum*

Aluminum that has had no annealing or hardening.

Dead Stretch*

The ability for a tape to be pressed into a depression and stay in place as if it were "dead" or without "memory/recovery."

Delamination

A separation or splitting of the tape such as separation of the backing into two distinct layers, separation between laminations of a tape consisting of more than one backing, separation between filaments and backing of a filament reinforced tape, or separation of the adhesive from the backing.

Dewetting*

When a paint appears to bead up or not flow out on a surface, like water on a freshly waxed car.

Dielectric Strength

The measure of the maximum voltage stress that a single layer of tape can withstand before dielectric failure occurs, the test being carried out under prescribed conditions.

Dimensional Stability

That property of a material that relates to the constancy of its dimensions, particularly in relation to external influences such as moisture or temperature.

Double Coated

An adhesive applied to both sides of a carrier.

Double Process*

A sandblasting procedure in which frosting is done first and sunk lines are done last. This requires frosted areas to be uncovered and recovered for the frosting process.

Edge Curl

The peeling back or lifting of the outer edge of an applied tape in a curved manner.

Edge Lift

The tendency for the edge of an adhesive label to lift from a surface to which it has been adhered.

Edge Seepage*

When paint gets under the edge of a tape, often appearing as hairlines of paint perpendicular to the tape edge.

Elasticity

The extensible property of adhesive films or adhesive interfaces to contract and expand in such a manner as to overcome the differential contraction and expansion rates that the bonded adherents may exhibit.

Elastomer

An elastic, polymeric substance, such as natural or synthetic rubber.

Electrolytic Corrosion Factor

A measure of the tape's corrosive effect on an electrical conductor, particularly copper. This is particularly important in the selection of tapes for electrical insulation.

Elongation (Stretch, Ultimate Elongation)

The distance a tape will stretch in the machine or cross direction before breaking under controlled conditions, expressed as a percentage of original length. Elongation is not necessarily an indication of conformability.

Emissivity*

All solid surfaces emit radiant energy. The emissivity of a material is a ratio of the actual energy emitted from that surface to the maximum possible, or "black body", radiant energy. The maximum possible emissivity is unity and it is a unit-less parameter.

Enamel Paint*

A broad classification of free-flowing pigmented finishing materials which dry to a smooth, hard finish and usually possess a gloss.

ESD*

ElectroStatic Discharge

Extruded*

A manufacturing process where material is forced through a nozzle (like extruded film or backing). Better for lay-flat than skived.

Face Stock

Any paper, film, fabric, laminate, or foil material suitable for converting into pressure sensitive material stock. In the finished construction this web is bonded to the adhesive layer and becomes the functional part of the tape construction.

Fall-off

When a tape pulls completely from the surface to which it is applied and drops off.

*Compiled by 3M.

Glossary (cont.)

F.A.R. 25.853(a)*

Federal Aviation Regulation 12-second vertical burn test.

Fatigue

A weakness resulting from stress created by repeated flexing or impact force upon the adhesive-adherent interface.

Filaments

Thin, longitudinal yarns or threads of glass, polyester, nylon or other high strength materials.

Fine Line*

Tapes that are used in the painting industry to give a very sharp paint line. Usually made with plastic type backings that are both smooth and conformable.

Flame Resistance

The ability of a tape to withstand exposure to flame. Fireproof materials will not burn even when exposed to flame. Flame-resistant (fire-retardant, self-extinguishing) materials will burn when exposed to flame, but will not sustain the burn after the flame is removed.

Flame Retardant*

Serving or tending to retard 1) slows flame propagation 2) meets industry regulations 3) is not flameproof 4) is not necessarily high temp performance.

Flatback Paper*

Paper with a flat (not crinkled) texture. This allows the paper to retain its original shape making it useful for maintaining a straight line and smooth backing feel.

Fluting

Distortion of a roll of tape such that the layers no longer form a circle.

Frosting*

Lightly removing the polish from a monument by using abrasive to give texture and a white contrast to the engraving.

Gapping

Openings between layers of tape within a finished roll.

General Paint Masking*

Where the paint line is important, but not critical to function or appearance on the finished part.

General Purpose Holding*

Where a tape is expected to temporarily hold miscellaneous items, such as during an assembly process.

Gloss

A light reflection characteristic of tape backings, usually expressed by such terms as glossy, low gloss, matte, etc.

Gross Masking*

Any material like paper or plastic that can be used to cover a large area, usually held in place with tape, that protects the area from paint overspray.

Hand-cut*

Cutting/carving design by hand to achieve desired pattern in sandblast stencil rubber.

Heat Seal

An adhesive film intended to be reactivated by the application of physical or chemical changes caused by exposure to high temperatures.

High Holding Strength — Masking*

Where a masking tape is expected to hold for long periods of time (several hours) to a surface to be painted or hold large areas of gross masking materials.

High Temperature Masking*

Where a masking tape is expected to withstand bake oven temperatures up to 300°F (149°C) for 30 minutes.

High Unwind*

When a tape is very difficult to unwind from its own roll. Can result in slivering off the roll.

High-Speed Unwind

A term referring to the process of unwinding or dispensing of tapes at a relatively high rate of speed, usually over 15 meters per minute.

Holding Power (Shear Adhesion, Shear Resistance)

The ability of a tape to resist static forces applied in the same plane as the backing. Usually expressed in a time required for a given weight and length of tape to shear free from a vertical panel.

Hot Melt (Pressure Sensitive Adhesive)

A pressure sensitive adhesive, applied to the backing in hot liquid form, which then cools to form a conventional pressure sensitive adhesive.

Humidity

The moisture content of the air. Actual humidity is the number of grams of moisture in the air at any given time. Relative humidity is the percent of moisture relative to the maximum that air at any given temperature can retain without precipitation.

Hygroscopic

A tendency of some materials to readily absorb moisture from the atmosphere.

Impact Resistance (Shock Resistance)

The ability of a tape to resist sudden impacts, pulls, or shocks as may sometimes be encountered by packages in transit.

Imprinting (Ghosting)*

Can occur when a vapor barrier, such as plastic sheeting, is placed over a painted surface and exposed to heat and/or UV. Moisture trapped under the plastic can't evaporate so it is driven back into the paint, leaving an imprint.

Insulation Resistance

The ability of tape to prevent the flow of electrical current across its surface, usually measured on the backing.

Label Stock

Pressure sensitive insulation materials furnished in roll or sheet form with liner, which can be later printed, frequently die-cut, and intended for use as labels.

Lacquer*

Various clear or colored synthetic organic coatings that typically dry to form a film by evaporation of a solvent, frequently a solution of cellulose derivative (as nitrocellulose).

Lap Joint

A joint made by lapping one material over another to provide a mated area that can be joined with an adhesive.

Latent Stain

A stain in a surface to which tape has been applied, which does not become noticeable until some time after the tape is removed, usually after the surface has been exposed to sunlight or heat.

*Compiled by 3M.

Glossary (cont.)

Latex Paint*

A water emulsion of plastic, obtained by polymerization, used especially in coatings that can recombine to form a thin film.

Leader Tape*

Used to splice photographic film leaders together for film processing.

Lifting

A situation where a section of tape has been pulled away from the surface to which it has been applied.

Low Adhesion Backsize (LAB)*

Surface treatment on the back (non-adhesive coated side) of a tape that allows tape to unwind when in roll form. It also helps coatings like paint to stick to its surface to prevent paint flaking.

Low Tack Masking*

Where a very low removal force is desired, often for use on delicate surfaces.

Low Temperature Masking*

Where a masking tape is expected to withstand bake oven temperatures up to 200°F (93°C) for 30 minutes.

Medium Temperature Masking*

Where a masking tape is expected to withstand bake oven temperatures up to 250°F (121°C) for 30 minutes.

Metal Foil

Thin, flexible sheets of metal, such as aluminum, copper and lead, used as tape backings because of their inherent properties such as weather resistance, electrical conductivity, reflectivity, etc.

Moisture Vapor Transmission Rate

A measure of the rate of water vapor transmission through a pressure sensitive product usually measured in grams per square meter per 24 hours.

Necking Down*

When a tape's width is reduced (usually due to stretching or elongating the tape) resembling the neck of a beverage bottle.

Nomograph*

A graphical means of representing properties of a material or system as a function of multiple parameters. A nomograph is used to describe the storage modulus and loss factor of viscoelastic damping materials as a function of temperature and frequency.

NPE*

An NPE number is used to designate an experimental product. NPE products are often provided to customers for evaluation purposes only, and may or may not be commercialized.

Off-Core

A roll of tape in which the layers are in correct alignment, but the tape is displaced sideways on the core.

Off-Site Blasting*

Process where names and dates are blasted onto monument surface after installation of monument.

Oozing

A "squeezing out" of the adhesive from under the backing. Occurrence when a tape is in a roll form causes the edges of the roll to become tacky.

Opacity

The ability of a tape to prevent the transmission of light.

Opaque*

Cannot be seen through.

Out-Gassing

The release of volatile components under heat or vacuum.

Overspray*

Light coating of paint, usually from excess airborne paint, that can drift onto adjacent surfaces that should not be coated.

Overlap Joint (Overlap Splice, Lap Splice, Lap Join or Lap Joint)*

A type of adhesive joint, used normally on roll goods, in which the surface of one edge of the product extends over the edge of the product to be spliced normally at least one half inch, and is spliced with a single coated tape, adhesive or double coated tape.

Paint Flaking*

The breaking of paint (that has been dried on the back of a tape) into small pieces such that when the tape is flexed, as during removal from a job, it falls off the back of the tape.

Pattern Coated

A term that refers to the width and spacing arrangement of strips of adhesive laid down parallel to machine direction and across the width of pressure sensitive stock during its production.

PCB*

Printed Circuit Board

PE*

The abbreviation for polyethylene. Usually extruded in a single (mono) layer.

Peel Adhesion

The force per unit width required to break the bond between a pressure sensitive adhesive tape and the surface to which it has been applied when the tape is peeled back at a controlled angle at a standard rate and condition.

Picking and Weeding*

The process of removing the cut stencil pieces prior to sandblasting.

Plastic Sheeting*

Large area plastic film used to cover or protect a surface or area from airborne particles.

Plasticization

The softening of an adhesive when exposed to migrating plasticizers or oils.

Plotters/Cutters*

Computerized machines that cut lettering and designs into sandblast stencil are called plotters. There are IBM compatible plotters that require a "T" punch, Gerber plotters that require a "S" punch and friction plotters that require no punch.

PP*

Abbreviation for polypropylene. Usually manufactured as a single (mono) layer via a casting process.

*Compiled by 3M.

Glossary (cont.)

PPAP*

Production Part Approval Process — an automotive market requirement that can increase a product's chances of meeting specifications.

Pressure Sensitive

A term commonly used to designate a distinct category of adhesive tapes and adhesives which in dry form (solvent/water free) are aggressively and permanently tacky at room temperature and that firmly adhere to a variety of dissimilar surfaces upon mere contact without the need of more than finger or hand pressure. These products require no activation by water, solvent, or heat in order to exert a strong adhesive holding force toward such materials as paper, plastic, glass, wood, cement, and metal. They have sufficient cohesive holding power and elastic nature so that, despite their aggressive tackiness, they can be handled with the fingers and removed from smooth surfaces without leaving a residue.

Priming

Application of a thin layer of adhesive-like material to a backing that serves as a bonding agent between the backing and the final adhesive coat.

PTFE*

Abbreviation for polytetrafluoroethylene.

Quick Stick (Finger Tack, Initial Adhesion, Wet Grab)

See TACK.

Release Force

The measure of the force required to separate a unit width of pressure sensitive tape from a release coated surface at a controlled angle and speed.

Release Liner

A web of sheet material used as a protective liner, which covers the adhesive side of the tape. It is removed prior to application. Most frequently found on double-sided tapes and label stocks.

Repulpable*

Paper tapes that can be recycled to the process without contamination of the broke pulp.

Resonant Vibration*

A condition of oscillation caused when a small amplitude of periodic input has a frequency approaching one of the natural frequencies of the driven system. Resonant frequencies are determined by the physical parameters of the object or system. i.e. Marching troops “break step” when marching over a bridge such as to not to vibrate the bridge in resonance in the event the natural frequency of the bridge structure matches the frequency of the troops marching in step.

Rewinding

The operation of winding the webstock from the reel onto a core to produce rolls of the desired width, diameter and tension.

Rope Stock

A smooth paper made wholly or largely of hemp fiber for tensile strength.

Rubber Adhesive*

A pressure sensitive, viscoelastic blend of polymeric rubber-based materials and tackifying resin. The rubber materials may be natural or synthetic. Rubber adhesives are a very broad class of materials and come in many types to achieve different properties.

Sandblast Filler*

Adhesive that is brushed on monuments to assure firm adhesion of stencil.

Saturation (Impregnation)

Adding materials (saturant) to the backing for improvement of physical properties and resistance to various deleterious environments.

Self-Seal

An adhesive joint that is accomplished by coating both adherent surfaces, and bringing them under pressure; an elastomeric adhesive (cohesive) used on envelope flaps, box closures, etc, whereby the adhesive film will bond only to itself.

Shear Adhesion

The time required, under specified test conditions (surface area, weight load), to slide a standard area of pressure sensitive tape from a standard flat surface in a direction parallel to the surface.

Shear Strength After Solvent Immersion

The force required to separate a bond by shear force after immersion in a typical varnish solvent under designated conditions.

Sheet Resistivity*

A measure of electrical resistivity obtained by measuring the voltage drop across two opposite sides of a square planer area at known current. The geometry of this measurement allow a square of any size to be used. Sheet resistivity is commonly used to measure the electrical characteristics of thin films. Units are ohms or more commonly ohms/square.

Silicone Adhesive*

A pressure sensitive, viscoelastic blend of polymeric silicone-based materials and a silicone tackifying resin. Silicone adhesives are typically higher temperature performing pressure sensitive adhesive materials.

Single Faced (Coated)

A tape to which a pressure sensitive adhesive is applied to only one side of the backing.

Single Process*

A sandblasting procedure in which sunk lines are sandblasted first and frosting is done last.

Sinking/Blasting*

Blowing sandblast abrasive at areas where the rubber has been removed to create recessed lines one half inch deep.

Skived*

A manufacturing process where material is shaved (like shaving off a layer of soap). Usually better for wrapping than extruded material.

Slip Sheet or Interliner

See RELEASE LINER.

Slivering

When the tape tears or breaks into small pieces, either on unwind or on removal from a surface.

Slot Feed*

A punched “S” pattern using several round holes and a long, oblong slot hole.

Solvent/Chemical Resistant*

Ability to resist common solvents or chemicals.

*Compiled by 3M.

Glossary (cont.)

Solvent Trap*

When a freshly painted surface is painted or taped over too quickly not allowing the solvent to evaporate. Can result in a haze, surface takes on the shape of what ever touches it, adhesive transfer due to solvents attacking the adhesive on the tape.

Splice*

A joint made in a continuous sheet of paper with a glue or adhesive-type tape when there is a break in the web caused by winding or rewinding into a roll.

Static Charge*

Static (or sometimes electro-static) charge is electrical charge that has typically been generated by the tribocharging that results from the separation of two dissimilar materials. It may also occur as the result of previous direct contact with a power source. Usually measured in volts.

Static Dissipative*

A class of materials with sufficient electrical conductivity to dissipate or bleed static charge prior to an ESD "event" or rapid discharge of energy. Static dissipative materials have electrical resistivities in-between semi-conductors and insulators, typically between 1E09 ohms/sq and 1E12 ohms/sq.

Stencil Press*

A machine that presses and cuts plastic letters into rubber stencil.

Subsequent Adhesion

The force required to remove a unit width of pressure sensitive tape from a standard panel after it has been in contact with a release liner for a given period of time. This must be compared with the adhesion of the same tape that has not been in contact.

Sunk Lines*

Individual lines about 1/16" wide or larger that create lettering and designs.

Sunlight Exposure — up to 7 days*

When exposure to direct sunlight is expected, even on a transparent surface like glass.

Surface Energy (Surface Wetting Ability)

The measure of surface tension in dynes. The lower the surface energy of a substrate, the more difficult it becomes for an adhesive or coating to wet out that surface.

Surface Treating

Any method of treating a polyolefin so as to alter the surface and render it receptive to inks, paints, lacquers and adhesives such as chemical, flame and electronic oxidation.

Tack

The property of a pressure sensitive adhesive that allows it to adhere to a surface under very slight pressure. It is determined by the ability of the adhesive to wet quickly the surface it contacts.

Tape Lifting*

When a tape prematurely releases from a surface after it has been firmly rubbed down to the surface.

Tear Resistance

The force required to propagate a tear in a tape in a given direction after the tear has been initiated.

Telescoping

A sideways sliding of the tape layers, one over another, such that the roll looks like a funnel or a telescope, usually occurring over a period of time.

Tensile Strength

The force required to break a unit width of tape by controlled pulling on opposite ends of the piece.

Thermal Conductivity*

The rate of thermal energy transfer through a material by conduction.

Thickness (Caliper, Gauge)

The perpendicular distance from one surface of either a tape, backing or adhesive to the other, usually expressed in mils, thousandths of an inch or millimeters. This is usually measured under controlled slight pressure with a special gauge.

Tractor Feed*

A punched "T" pattern using round holes.

Transfer Tape

A pressure sensitive adhesive unsupported applied to a two-side release coated liner.

TSCA*

Toxic Substances Control Act

UHMW-PE Film*

Ultra High Molecular Weight.

UL Listed*

Underwriter Laboratory certification of products for product compliance for public safety (i.e. electronics, heating and ventilation, etc.) as well as businesses for compliance to industry standards (i.e. ISO).

UL 181*

UL181A, UL181B, and UL181B-FX are different in that those must be UL Listed and that information must be printed on the tape surface. HVAC/R contractors often deal with UL 181A (maybe foils) and UL 181 F-FX.

UL 723*

UL 723 deals mainly with flammability.

Unwind or Unwind Adhesion

The force required to remove tape from a roll under prescribed conditions.

Use on Masking Machines*

When tape and a gross masking material are automatically dispensed on a piece of equipment and applied to each other for large area protection from paint overspray.

Varnish*

A liquid preparation that when spread and allowed to dry on a surface forms a hard lustrous typically transparent coating.

Water Penetration Rate (WPR)

The weight of water transmitted through a controlled area of tape under a specified time and conditions.

Water Vapor Transmission (WVTR)

The weight of water vapor allowed through a controlled area of tape within a specified time period and under controlled conditions.

*Compiled by 3M.

Numerical Index

Product	Page	Product	Page	Product	Page	Product	Page
06780.....	46	31U26/UV	18	415/9420	42	685.....	25
06781.....	46	31U82P	18	420.....	29	695.....	25
06864.....	46	31U84P	18	421.....	29	764.....	37
06865.....	46	44S56W.....	18	425.....	28	766.....	37
06866.....	46	64S58W.....	18	427.....	28	767.....	37
2.....	21	101+	6, 9	431.....	28	838.....	25
2A87	17	200.....	9	433.....	28	850.....	33
2A88	17	201+	6, 9	433L.....	28	853.....	33
2A89	17	202.....	9	434.....	31	855.....	25
2A804	17	203.....	9	435.....	31	900.....	41
2A825	17	213.....	9	436.....	31	900B	41
2A826	17	214.....	9	437.....	28	901.....	41
2A829	17	215.....	7	438.....	28	906.....	41
2AU23B/UV	18	218.....	7	438L.....	28	910.....	41
2AU26B/UV	18	218L.....	7	439.....	28	913.....	42
2E79.....	17	225.....	9	465.....	42	914.....	41
2E93/EZ.....	17	226.....	9	469.....	42	1001MS.....	15
2E95/EZ.....	17	231/231A	9	470.....	37	1002MS.....	15
2E97.....	17	232.....	9	471.....	37	1004.....	15
2E98.....	17	234.....	9	471+	37	1004MS.....	15
3.....	21	235.....	25	472.....	37	1430.....	30
3W25X.....	18	250.....	12	477.....	37	1532.....	21
3W26X.....	18	253.....	25	480.....	37	1532S.....	21
3W29X.....	18	256.....	12	481.....	19	1532T.....	21
3W55X.....	18	265.....	7	483.....	37	1614.....	18
4F94.....	17	301+	6, 9	484.....	37	1675.....	18
4H81CPK	18	335.....	33	500.....	21	1900.....	11
4H81WPK	18	335/Pink.....	19	501+	6, 9	2187.....	19
4H85CPB	18	336.....	33	507.....	21	2214.....	9
4H85WPB	18	336/Clear.....	19	510.....	21	2307.....	9
5A829	17	346.....	25	519Y.....	21	2308.....	9
15CV804	17	346/Tan	19	519YP.....	21	2364.....	9
15CV825	17	361.....	26	519YP2.....	21	2380.....	9
15CV826	17	363.....	30	519YP2S.....	21	2393.....	9
24S56W.....	18	363L.....	30	519YP2T.....	21	2460.....	7
25A825	17	365.....	26	519YPS.....	21	2480S.....	7
25A826	17	390.....	11	519YPT.....	21	2510.....	9
25A829	17	393.....	11	519YS.....	21	2515.....	12
25A87	17	394.....	25	519YT.....	21	2517.....	12
25A88	17	396.....	33	520.....	21	2525.....	12
25A89	17	398FR.....	26	520ETL.....	21	2526.....	12
25M25X.....	18	398FRP.....	26	520S.....	21	2542.....	31
25M26X.....	18	399FR.....	26	520T.....	21	2552.....	31
25X126.....	18	401+	6, 9	528.....	21	2693.....	9
31U23/UV	18	405.....	41	616.....	25	2929.....	11

Numerical Index (cont.)

Product	Page	Product	Page	Product	Page	Product	Page
2979.....	11	4737TL.....	7	8777.....	25	33806.....	28
3051.....	25	4811.....	19	8901.....	33	34201.....	29
3130.....	17	5151/5151L/5151PL.....	35	8902.....	33	34383.....	29
3179.....	19	5153/5153L.....	35	8905.....	33	41825.....	19
3187.....	19	5180.....	35	8911.....	33	41826.....	19
3188.....	19	5181.....	35	8979.....	11	51825.....	19
3294.....	25	5187.....	19	8979N.....	11	51826.....	19
3302.....	30	5188.....	19	8991/8991L.....	33	97065.....	29
3311.....	29	5193EZ.....	17	8992/8992L.....	33	GM110.....	38
3313.....	29	5401.....	25	8997/8997L.....	25	GM400.....	38
3320.....	30	5421.....	35	8998/8998L.....	25	GM530.....	38
3325.....	29	5423.....	35	9038.....	42	GM531.....	38
3334.....	30	5425.....	35	9069.....	41	GM613.....	38
3338.....	28	5430.....	35	9069.....	42	GM614.....	38
3340.....	30	5451.....	35	9086.....	42	GM630.....	38
3350.....	30	5453.....	35	9088.....	42	GM631.....	38
3361.....	29	5461.....	25	9103.....	41	GM640.....	38
3363.....	29	5480.....	35	9114.....	41	GM641.....	38
3367.....	29	5481.....	35	9324.....	35	GM731.....	38
3369.....	29	5490.....	35	9325.....	35	H330.....	45
3380.....	29, 30	5491.....	35	9343.....	25	H331.....	45
3381.....	30	5498.....	35	9343/Black.....	19	M1.....	45
3382.....	30	5700.....	37	9498/9464.....	42	M73.....	45
3615.....	26	5702.....	37	9499/9497.....	42	M75.....	45
3650.....	26	5850.....	14	9576.....	42	M77.....	45
3900.....	11	5903.....	11	9737/9737R.....	42	R3037.....	41, 42
3903.....	11	5959.....	11	9738/9738R.....	42	R3127.....	41, 42
3939.....	11	6910.....	11	9740.....	42	R3177.....	41, 42
3979.....	11	6969.....	11	9741/9741R.....	42	R3187.....	41, 42
4014.....	31	7260M.....	12	9960.....	41	R3227.....	41, 42
4130.....	17	7300.....	12	9969.....	41	R3257.....	41
4167.....	19	8067.....	25	9977.....	41	R3287.....	41
4179.....	19	8087.....	25	9990N.....	42	R3345.....	41
4187.....	19	8179.....	19	21804.....	19	R3375.....	41
4188.....	19	8401.....	33	21825.....	19	R3379.....	41
4193/EZ.....	17	8402.....	33	21826.....	19	R5348.....	42
4195/EZ.....	17	8403/8403L.....	33	31804.....	19	R7359.....	42
4201.....	29	8411.....	33	31825.....	19	R7369.....	42
4380.....	29	8412.....	33	31826.....	19	R9993.....	42
4712.....	37	8421.....	33	31829.....	19	R9996.....	41
4731.....	37	8422.....	33	33315.....	29	R9999.....	41
4735.....	7	8429.....	33	33316.....	29	RTA500.....	45
4737S.....	7	8437.....	33	33801.....	28	S170.....	45
4737T.....	7	8555.....	25	33803.....	29	S171.....	45

Product Name Index

Application Specific Tapes

235.....	25
616.....	25
3051.....	25
8997/8997L.....	25
8998/8998L.....	25
685.....	25
695.....	25
394.....	25
3294.....	25
855.....	25
8555.....	25
8067.....	25
8087.....	25
253.....	25
346.....	25
838.....	25
5401.....	25
5461.....	25
8777.....	25
9343.....	25

Clean-View Pads

5850.....	14
-----------	----

Duct Tapes and Cloth Tapes

8979.....	11
8979N.....	11
5959.....	11
5903.....	11
2979.....	11
3900.....	11
3939.....	11
3979.....	11
6969.....	11
3903.....	11
2929.....	11
1900.....	11
390.....	11
393.....	11
6910.....	11

Fine Line Masking Tapes

215.....	7
218.....	7
218L.....	7
265.....	7
2460.....	7
2480S.....	7
4735.....	7
4737T.....	7
4737S.....	7
4737TL.....	7

Flatback Tapes

250.....	12
256.....	12
2515.....	12
2517.....	12
2525.....	12
2526.....	12

Glass Cloth Tapes

361.....	26
3615.....	26
365.....	26
3650.....	26
398FR.....	26
398FRP.....	26
399FR.....	26

Gripping Materials

GM110.....	38
GM530.....	38
GM613.....	38
GM630.....	38
GM640.....	38
GM400.....	38
GM531.....	38
GM614.....	38
GM631.....	38
GM641.....	38
GM731.....	38

Industrial Masking Tapes

101+.....	6
201+.....	6
301+.....	6
401+.....	6
501+.....	6

Lane Marking Applicators

M1.....	45
M77.....	45

Large Area Masking Dispensers

06781.....	46
06780.....	46
06864.....	46
06865.....	46
06866.....	46

Masking Films

7260M.....	12
7300.....	12

Masking Tapes — Crepe Paper

101+.....	9
201+.....	9

301+.....	9
401+.....	9
501+.....	9
200.....	9
202.....	9
203.....	9
213.....	9
214.....	9
225.....	9
226.....	9
231/231A.....	9
232.....	9
234.....	9
2214.....	9
2307.....	9
2308.....	9
2364.....	9
2380.....	9
2393.....	9
2510.....	9
2693.....	9

Metal Foil Tapes

425.....	28
427.....	28
431.....	28
433.....	28
433L.....	28
437.....	28
438.....	28
438L.....	28
439.....	28
3338.....	28
33801.....	28
33806.....	28
3311.....	29
3369.....	29
33803.....	29
97065.....	29
3380.....	29
4380.....	29
34383.....	29
3363.....	29
3367.....	29
420.....	29
421.....	29
4201.....	29
34201.....	29
3313.....	29
3325.....	29
33315.....	29
33316.....	29
3361.....	29
363.....	30

363L.....	30
1430.....	30
3302.....	30
3334.....	30
3320.....	30
3340.....	30
3350.....	30
3380.....	30
3381.....	30
3382.....	30

Multi-Layer Protective Film

1004.....	15
1004MS.....	15
1002MS.....	15
1001MS.....	15

Non-Repulpable Splicing Tapes

465.....	42
9498/9464.....	42
9499/9497.....	42
415/9420.....	42
469.....	42
9086.....	42
9088.....	42
9576.....	42
9737/9737R.....	42
9738/9738R.....	42
9740.....	42
9741/9741R.....	42

Polyester Tapes

396.....	33
850.....	33
853.....	33
8411.....	33
8412.....	33
335.....	33
336.....	33
8401.....	33
8402.....	33
8403/8403L.....	33
8901.....	33
8902.....	33
8905.....	33
8911.....	33
8991/8991L.....	33
8992/8992L.....	33
8421.....	33
8422.....	33
8429.....	33
850.....	33
8437.....	33

Product Name Index (cont.)

Polyethylene Tapes	31U82P	18	914.....	41	Splicing Tapes for the Printing Industry
480.....	31U84P	18	9103.....	41	R3037
483.....	3W25X.....	18	9114.....	41	R3127
	3W26X.....	18	9960.....	41	R3187
Preservation Tapes	3W29X.....	18	9969.....	41	R3177
481.....	3W55X.....	18	R3037	41	913.....
4811.....	21804.....	19	906.....	41	9038.....
	21825.....	19	9069.....	41	9069.....
Protective Tapes	21826.....	19	9977.....	41	R3227
25A825	2187.....	19	R3227	41	R5348
25A826	3179.....	19	R3257	41	R7359
25A829	31804.....	19	R3287	41	R7369
25A87	31825.....	19	R3127	41	9990N
25A88	31826.....	19	R3177	41	R9993
25A89	31829.....	19	R3187	41	
2A804	3187.....	19	R3345	41	Tape Dispensers
2A825	3188.....	19	R3375	41	H330
2A826	4167.....	19	R3379	41	H331
2A829	4179.....	19	R9996	41	M73.....
2A87	41825.....	19	R9999	41	M75.....
2A88	41826.....	19			RTA500.....
2A89	4187.....	19	Sandblast Stencil Products and Impact Stripping Tapes		S170.....
5A829	4188.....	19	519Y.....	21	S171.....
2E79.....	51825.....	19	519YS.....	21	
2E93/EZ.....	51826.....	19	519YT.....	21	UHMW-PE Tapes
2E95/EZ.....	5187.....	19	519YP2.....	21	5421.....
2E98.....	5188.....	19	519YP2S.....	21	5423.....
2E97.....	8179.....	19	519YP2T.....	21	5425.....
4193/EZ.....	335/Pink.....	19	519YP.....	21	5430.....
5193EZ.....	336/Clear.....	19	519YPS.....	21	9324.....
4195/EZ.....	346/Tan	19	519YPT.....	21	9325.....
4F94.....	9343/Black	19	507.....	21	
15CV804			510.....	21	Vinyl Tapes
15CV825	PTFE Tapes		520.....	21	471.....
15CV826	5151/5151L/5151PL.....	35	520S.....	21	4712.....
3130.....	5153/5153L.....	35	520T.....	21	471+
4130.....	5451.....	35	520ETL	21	472.....
4H81CPK	5453.....	35	1532.....	21	477.....
4H81WPK	5180.....	35	1532S.....	21	764.....
4H85CPB	5181.....	35	1532T.....	21	5700.....
4H85WPB	5480.....	35	500.....	21	5702.....
1614.....	5481.....	35	528.....	21	766.....
1675.....	5490.....	35	2.....	21	767.....
24S56W.....	5491.....	35	3.....	21	470.....
44S56W.....	5498.....	35			484.....
64S58W.....			Sound Damping Foils		4731.....
25M25X.....	Reulpable Splicing Tapes for the Paper Mills		434.....	31	
25M26X.....	405.....	41	435.....	31	
25X126.....	900.....	41	436.....	31	
2AU23B/UV	900B	41	2542.....	31	
2AU26B/UV	901.....	41	2552.....	31	
31U23/UV	910.....	41	4014.....	31	
31U26/UV					

Product Use: Many factors beyond 3M's control and uniquely within user's knowledge and control can affect the use and performance of a 3M product in a particular application. Given the variety of factors that can affect the use and performance of a 3M product, user is solely responsible for evaluating the 3M product and determining whether it is fit for a particular purpose and suitable for user's method of application.

Warranty, Limited Remedy, and Disclaimer: Unless an additional warranty is specifically stated on the applicable 3M product packaging or product literature, 3M warrants that each 3M product meets the applicable 3M product specification at the time 3M ships the product. 3M MAKES NO OTHER WARRANTIES OR CONDITIONS, EXPRESS OR IMPLIED, INCLUDING, BUT NOT LIMITED TO, ANY IMPLIED WARRANTY OR CONDITION OF MERCHANTABILITY OR FITNESS FOR A PARTICULAR PURPOSE OR ANY IMPLIED WARRANTY OR CONDITION ARISING OUT OF A COURSE OF DEALING, CUSTOM OR USAGE OF TRADE. If the 3M product does not conform to this warranty, then the sole and exclusive remedy is, at 3M's option, replacement of the 3M product or refund of the purchase price.

Limitation of Liability: Except where prohibited by law, 3M will not be liable for any loss or damage arising from the 3M product, whether direct, indirect, special, incidental or consequential, regardless of the legal theory asserted, including warranty, contract, negligence or strict liability.

3M, Scotchgard and Tartan are trademarks of 3M Company.

Scotch is a registered trademark of 3M Company.



3M Industrial Adhesives and Tapes Division

3M Center, Building 225-3S-06
St. Paul, MN 55144-100
800-362-3550 877-369-2923 (Fax)
www.3M.com/IATD

Please recycle. Printed in USA.
© 3M 2014. All rights reserved.
70-0709-4473-4 Rev Jan2015